

# INSTALLATION AND OPERATION MANUAL

# FORZA STi





## **LETTER TO CUSTOMERS**

Pratica Inc. are proud to become part of your day-to-day lives with our products. By purchasing Pratica's appliances, you will have a partner that always will be attentive to your needs and interested in keeping customers satisfied.

We are available to serve you at any time, whether it is to hear your ideas, criticisms, suggestions, or solve a problem.

*Count on us!*

### **Our Mission**

Bring quality and productivity to the food preparation environment.

### **Our Commitment**

- *To know and meet the needs of our customers.*
- *Offer reliable, high-performance, and energy-efficient products.*
- *Always looking for improvements of processes, products and cost to offer more value to our customers every single day.*
- *Treat our customers with complete honesty and respect.*
- *Prática Inc. donates a portion of our profit to charitable causes.*

## SUMMARY

### IMPORTANT SAFETY INSTRUCTIONS

Use Recommendations.....06

**IDENTIFICATION OF SYMBOLS USED IN THIS MANUAL.....08**

### WARRANTY TERM

Terms and Detailing.....09

Warranty Exclusions.....10

Notes and Recommendations..... 11

### INSTALLATION INSTRUCTIONS

Electrical Installation.....12

General Instructions.....13

Dimensions.....14

General Recommendations.....15

**FORZA STi TECHNOLOGY.....16**

### OPERATING INSTRUCTIONS

Preheating.....17

Executing a Recipe.....18

Accessing Options.....21

User Settings.....22

• *Edit Groups*.....23

• *Edit Name*.....24

• *Edit Group Image*.....24

• *Deleting Group Recipes*.....27

• *Order - Group*.....28

• *Change Group Temperature*.....28

• *Edit Recipes*.....29

• *Edit Recipe Name*.....30

• *Edit Recipe Image*.....31

• *Edit Steps*.....33

• *Deleting Recipes*.....33

• *Order - Recipes*.....34

• *Edit "Brown More"*.....35

• *Add/Remove from Favorites*.....36

• *Preheat*.....37

## SUMMARY

### OPERATING INSTRUCTIONS

• <i>Usb</i> .....	38
• <i>Language</i> .....	39
• <i>Current Temperature</i> .....	39
• <i>Date/Time Adjustment</i> .....	40
• <i>Celsius/Fahrenheit</i> .....	41
• <i>Change Password</i> .....	41
• <i>Edit Access</i> .....	42
• <i>Manufacturer's Information</i> .....	42
• <i>Tech Support</i> .....	43
• <i>Restore Factory Settings</i> .....	43

Favorites.....	44
----------------	----

Sound Alarms.....	44
-------------------	----

Manual Mode.....	45
------------------	----

### HYGIENIZATION

Daily Cleaning Guide.....	47
---------------------------	----

Catalytic Converter Cleaning Guide.....	49
---	----

Air Filter Cleaning Guide.....	49
--------------------------------	----

Door Glass Cleaning Guide.....	50
--------------------------------	----

### ALERTS AND ERRORS: POSSIBLES SOLUTIONS

Alerts.....	51
-------------	----

Errors.....	52
-------------	----

# IMPORTANT SAFETY INSTRUCTIONS

## USE RECOMMENDATIONS

- Oven operation: It is recommended that the oven operator always wear thermal protection gloves and an apron to prevent burns on the inside of the oven and possible spillage of the contents of the trays
- Use of the panel: The panel must be operated with fingers only, the use of any instrument can damage or equip and jeopardize the operator's safety.

**CAUTION:** To avoid burns, do not use containers with liquids or kitchen products that become liquids by heating up to a boiling point. **This marking must be mounted after the installation at 63in / 5ft / 1.6m above floor level.**



- Remove wires used to seal paper or plastic bags that will be into the oven. Do not use plastic utensils.
- Do not allow children to use or operate this equipment.
- Do not use the equipment if it is damaged, specially if the oven's door should always close properly.
- Do not place any object between the inner cavity and the oven door, obstructing the door from closing.
- Use this equipment only for the functions described in this manual.

## USE RECOMMENDATIONS (continuation)

### CAUTION!

- The equipment is not intended for use by persons (including children) with reduced physical, sensory or mental capabilities, or that have not been properly trained to operate the unit.



- Do not use the oven handle to move the equipment. The oven must be moved exclusively from its sides.



- Do not use the equipment door as support. This will cause unevenness of the door and equipment malfunction.



- The oven door is only intended for sealing microwaves generated during cooking. Using the door for any other purpose not described in this manual may void the warranty.

## IDENTIFICATION OF SYMBOLS USED IN THIS MANUAL



DANGER! THREAT OF RISK THAT MAY CAUSE SERIOUS INJURY OR DEATH



ALERT



**WARNING - FIRE RISK** - TO REDUCE THE FIRE RISK DO NOT REMOVE THIS COVER. NO USER-SERVICEABLE PARTS INSIDE. REPAIR SHOULD BE DONE BY AUTHORIZED SERVICE PERSONNEL ONLY



**WARNING - RISK OF ELECTRIC SHOCK** - TO REDUCE THE RISK OF ELECTRIC SHOCK DO NOT REMOVE THIS COVER. NO USER-SERVICEABLE PARTS INSIDE. REPAIR SHOULD BE DONE BY AUTHORIZED SERVICE PERSONNEL ONLY



**WARNING - BURN RISK** - DO NOT TOUCH ANY PART WITH THIS SYMBOL WHILE THE OVEN IS IN OPERATION.



**WARNING - RISK OF BURN FROM SPILLING OF HOT LOAD** - TO AVOID BURNS, DO NOT USE CONTAINERS WITH LIQUIDS OR KITCHEN PRODUCTS THAT BECOME LIQUIDS BY HEATING UP TO A BOILING POINT.



GROUNDING SYMBOL



EQUIPOTENTIAL SYMBOL



USE TIPS AND INFORMATION



## WARRANTY TERM

### TERMS AND DETAILING

- a) Our products are warranted for twelve 12 months for parts and labor, and twenty-four months for the all heating element parts; from the date the product is installed. If, for any reason, there is no record of the installation date nor the purchase invoice is not found, the date of manufacture of the equipment contained on the indicative label will be considered the date of beginning of the applicability of this guarantee.
- b) If new visits are needed to complete the delivery/installation of the product due to the lack of adequate, electrical, or exhaust related conditions, the costs of such visits shall be the customer's responsibility.
- c) For the appliance's installation, the customer must provide all conditions required (208v/240v single phase) in the installation blueprint. The customer will also be responsible for transporting the equipment to the installation site.
- d) The warranty only covers manufacturing and component failures, damages caused by lack of heeding label warnings on the product will not be covered.
- e) The warranty will cover adjustments and replacement of defective parts. It is the responsibility of the authorized service technician to return the defective parts to Pratica Inc. for analysis when requested by the Manufacturer.
- f) Warranty service calls will not justify the extent of the warranty, returns or exchanges of the equipment, or any other type of claim.

## WARRANTY EXCLUSIONS

- a) The customer should thoroughly inspect the equipment upon delivery and contact the carrier in case of shipping damage arising from transport.
- b) Pratica will not respond for any issues arising for electrical building irregularities, or a lack of abiding to the local electrical code, will not be covered by the Warranty.
- c) Use or installation not in accordance with the Installation and Operation Manual accompanying the product.
- d) Failure to observe the installation details per the Installation and Operation Manual, such as uneven floors, installing the oven next to equipment that exudes fat, heat or solid particles, lack of air circulation, etc.
- e) Any damage and defects resulting from inappropriate cleaning products that result in damages to the components will not be covered under warranty. For example, pouring water inside the electric panel, etc.
- f) Changes performed by unauthorized technicians in the original conditions of installation such as electrical distribution, installation location, etc.
- g) Use of aggressive or abrasive products that are unsuitable for cleaning which may tarnish, wear, scratch or damage accessories or equipment components.
- h) Occurrences from electrical discharges arising from acts of nature or voltage peaks caused by generators or power supply companies.
- i) Damage to the equipment or its accessories caused by accidents, improper operation, improper handling or installation as described by the Operation Manual included with this product.
- j) Repair attempts by unauthorized third parties or use of non-OEM parts and components, regardless of the damage or defects.

## NOTES AND RECOMMENDATIONS

- a) The operator should use the Installation and Operation Manual as a guide.
- b) Make sure that the electric systems are made and installed by a qualified company or technician.
- c) Before contacting technical assistance, check the manual for troubleshooting tips that can be solved without a technician. Always remember that Pratica must be contacted first before, contracting with a service agent.
- d) The wear and tear of the unit are not covered by warranty. To ensure productivity and increase the life of the product, it is essential to follow cleaning procedures regularly and keeping preventive maintenance guidelines.
- e) You can call our technical assistance to provide feedback, offer suggestions, or get assistance troubleshooting during normal business hours at **+1 214 584-6269** or **+1 469-583-4643**.

## EQUIPMENT IDENTIFICATION

*(Fill in to make technical support calls easier)*

MODEL			
VOLTAGE		SERIAL NUMBER	
RESELLER			
INVOICE NUMBER		PURCHASE DATE	

# INSTALLATION INSTRUCTIONS

## ELECTRICAL INSTALLATION

- Always follow the installation instructions in the instruction manual or the product's spec sheet. This form is attached to the manual, in addition to being sent by email upon approval of the order, it is also available on our website ([www.praticaus.com](http://www.praticaus.com)), in case of doubts, contact Practical Technical Assistance: **+1 214 584- 6269 or +1 469-583-4643**.
- The installation of the Prática ovens must be done with the necessary care to avoid problems, damage to the equipment, and guarantee its full use.
- This equipment must be installed by an authorized technician.



- The equipment **MUST** be grounded.
- The oven must have a dedicated circuit breaker.
- Do not immerse the power cable or connect water.
- Keep the power cord away from heated surfaces.
- If the power cable is damaged, it must be immediately replaced by an authorized technician to avoid shock hazards.
- Only qualified personnel should open the equipment panel.
- There is an equipotential point on the rear panel of the oven.

Forza STi	Voltage (V)	Phases	Freq. (Hz)	Power (kW)	Circuit Breaker (A)	Cable	Socket	
USA	208	Single	60	5.6	30	3x10 AWG	NEMA 6-30	
	240	Single	60	7.2	30			

## INSTALLATION INSTRUCTIONS

•**Note:** The equipment has a connector for interconnect it with other equipment. This connector is intended to keep several devices with the same electrical potential. Not necessarily the grounding of a local connection. This connector on the back of the device is identified by the symbol on the right:



- Use of pressure cables to prevent movement of the power cable.
- In case the oven voltage is 380 volts, a neutral cable (independent of the ground) must be available.

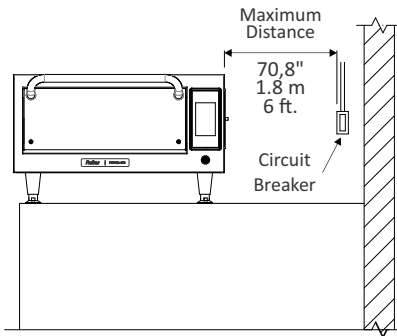

- Ensure that the electrical characteristics of the building network are in accordance with the technical specifications located on the data label located on rear panel of the unit. The building electrical is the customer's responsibility.
- This unit must be properly grounded to avoid electrical shock .
- The circuit braker should be located no more than 70,8in / 6ft / 1.8m away from the unit.

## GENERAL INSTRUCTIONS

- The oven must be installed on a surface or counter that supports its weight of approximately 148lb (67 Kg).
- Do not obstruct the air inlets and outlets at the bottom of the oven.
- The oven must not be positioned near stoves, deep fryers, hot plates and other equipment that releases fat, fumes and heat. The ventilation, electrical panel and motor vents must be far from these heat sources to prevent damage to the electrical system of the equipment.
- The oven must be installed in a leveled and well-ventilated area.
- The installation of the equipment in a non-suitable place can result in the loss of warranty.

# INSTALLATION INSTRUCTIONS

## DIMENSIONS

### FORZA STI

SIDE VIEW

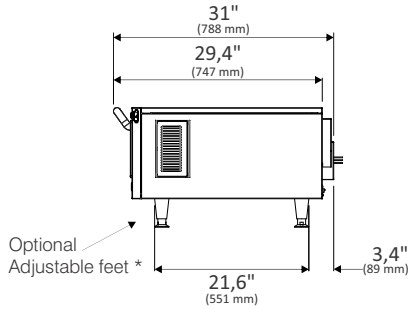

FRONT VIEW

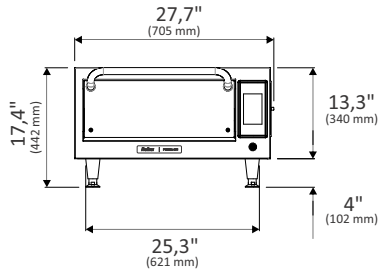

TOP VIEW  
WITH DOOR OPEN

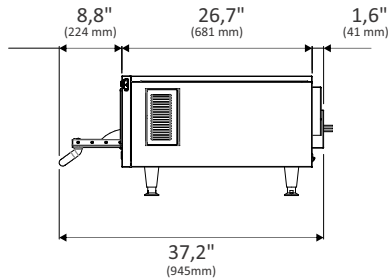

## PADDLE ASSEMBLY

Use the Allen wrench that comes with the paddle to assist the assembly.

ITEM	DESCRIPTION	QTY.
1	PADDLE BASE	1
2	GAUNTLET	1
3	400 MM CABLE	1
4	HAND PROTECTOR	1
5	FLAT HEAD SCREW M5 X 15 MM	2
6	ALLEN WRENCH	1

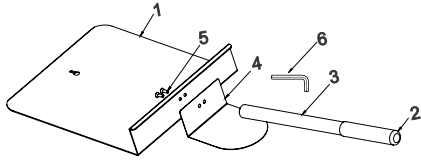

## GENERAL RECOMMENDATIONS



- Do not use this product near water, kitchen sink, wet places, or near a swimming pool.



- If residues accumulated inside the oven burn, keep the oven door closed, turn off the electrical power at the oven's exclusive circuit breaker and unplug the oven.



- Do not use the inside of the oven to dry clothes or store clothes.



- If the oven door is damaged, it must not be operated until it is repaired by a qualified person.

- If there is a power failure during any process in progress in the oven, this operation will be lost (saved recipes will not be lost).
- Do not cover or block any opening on the device.
- Do not use the oven outdoors.
- Do not store food inside the oven when it is not in operation.
- When activating the oven circuit breaker, wait ten seconds to switch on the equipment.

Chamber Dimensions	
<b>Capacity</b>	0.65 cu.ft / 21 l
<b>Height</b>	3,6" / 93 mm
<b>Width</b>	18,1" / 460 mm
<b>Depth</b>	17,1" / 435 mm

## FORZA STi TECHNOLOGY

The **Forza STi** oven uses high-speed forced air convection to heat forced food more quickly than the conventional methods.

The figure below illustrates the steps involving the technology:

- *Internal heating elements transfer thermal energy to the circulating air.*
- *The blower motor circulates air at high speed and envelops the food.*
- *The circulating air goes through the catalyst where the grease-laden vapors are broken down.*
- *The bottom heater helps the heat transfer within the chamber.*

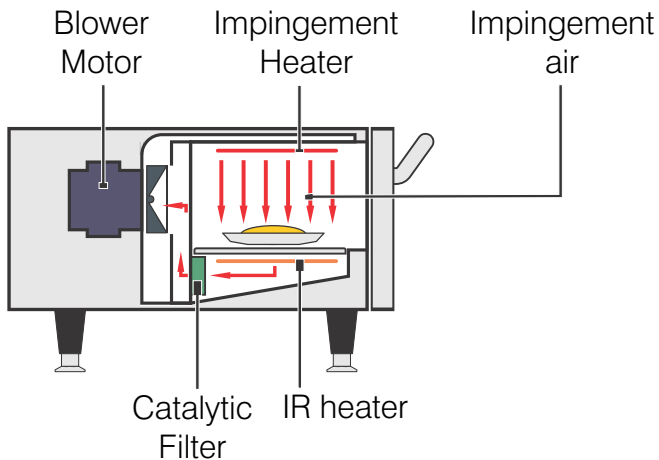



## OPERATION

### PREHEATING

a) To start the oven preheating process, after turning on the equipment, choose between Preheating Temperature 1 and Preheating Temperature 2.

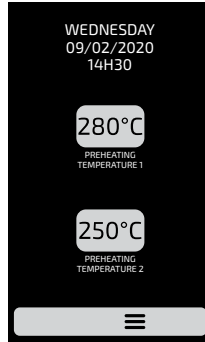

b) The following screen will present the **CURRENT, PROGRAMMED** temperature and the bar indicating the remaining time to utilize the equipment.

***Note:** The timer is only initiated when the CURRENT temperature is next to the PROGRAMMED; that occurs so that the oven temperature enters in uniformity throughout the chamber.*

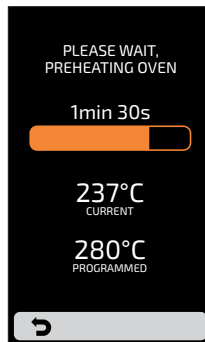

## EXECUTING A RECIPE

a) After the preheating.

- Activate the desired GROUP. To access the next groups page, utilize the paging arrows: ◀ / ▶ .

b) The RECIPES of the selected group will be displayed, press on the recipe you wish.

- To return to the GROUPS screen, push the button: 🏠 .
- To access the next recipes page, utilize the paging arrows: ◀ / ▶ .

***Make sure there is food inside the oven, otherwise it will cause damages to the equipment.***

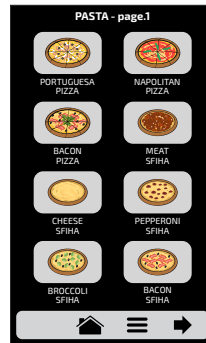

c) The recipe will enter in execution immediately.

d) The screen will present the group name, recipe name, situation of the operation (In progress or paused), and the remaining time for conclusion of the recipe.

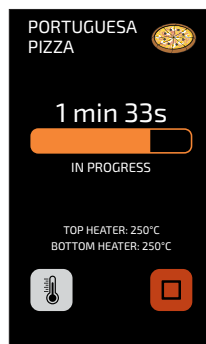

e) It is possible to verify the temperature of the TOP HEATER and of the BOTTOM HEATER pressing the  button.

f) In case you desire to cancel the execution of a recipe, push the  button.

g) If the equipment door is opened, the operation will be paused; once the door is closed again just push the  to resume the operation.

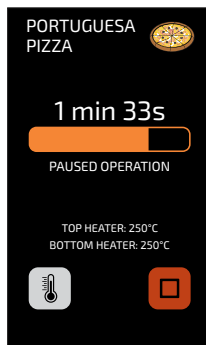
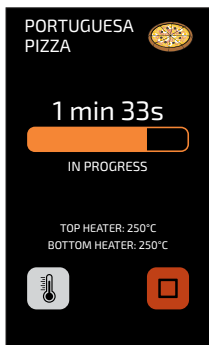

h) If the programmer of the recipes adds information in one of the steps, for example: 'ADD TOMATOES', the recipe will be paused and the description of the information will be presented beside the PLAY button, as in the image below:

- Push the  button to resume the operation.

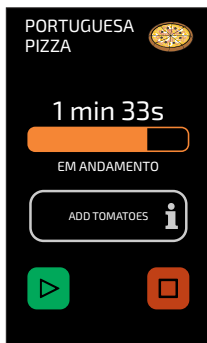

i) After the completion of a recipe, the following options will be released:

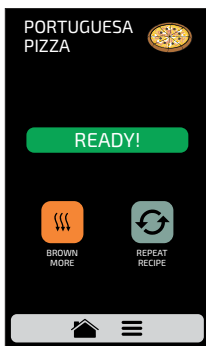

**Brown More:** Activates only the hot air during a predetermined time.



**Repeat Recipe:** Repeats the same recipe chosen by the user.

j) In “Brown More” the time will be defined at the moment of creating the recipe.

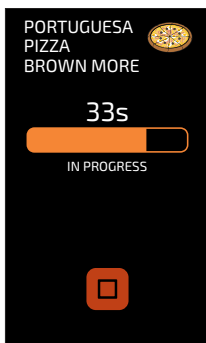

*Example of Brown More in execution:*

**k)** The two options mentioned above may be disabled so that they do not appear in any recipe. **Learn more in the User's Settings block: Edit Accesses (see page 41).**

## ACCESSING THE OPTIONS

a) To access the settings, at any time, touch on the icon  found in the fixed menu bar.

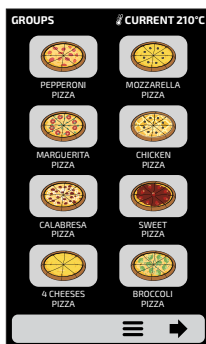

b) In the Options Screen, there will be information such as: Current temperature in the Chamber, Current temperature of Bottom Heater (IR), Favorites (see page 43), Manual Mode (see page 44), Daily Cleaning Guide (see page 46) and Settings (below).

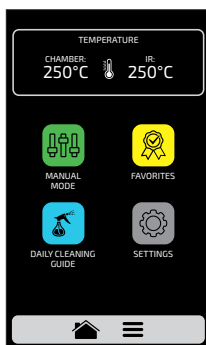

c) Touching on the icon  once more will return to Groups Screen.



d) Touching on the icon  will return to the Preheating Temperature selection screen.

## USER'S SETTINGS

a) Inside the Options Screen, click on the icon  on the screen to inform the User's Password that will be presented.

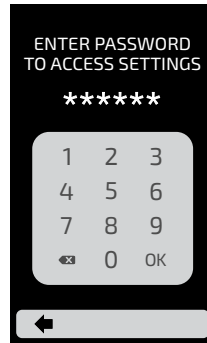
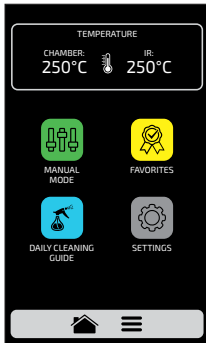
b) The standard password for the settings is 456789. The password may be changed (see page 40).



c) The User's Settings screen is composed by fourteen items. Use the arrows to access the next options screen:  /  . Understand each item in detail in the following pages.

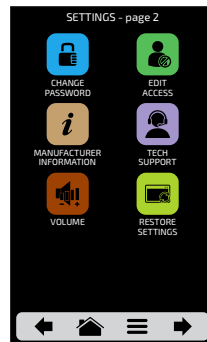

## USER SETTINGS: EDIT GROUPS

a) To edit the groups, touch on the  icon, the groups screen will be presented. However, in the first position will be the icon in which it is possible to Create New Group.

b) Choose between creating a new group, or select the group you desire to edit. It is possible to have up to a total of sixteen groups.

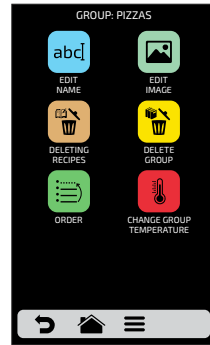
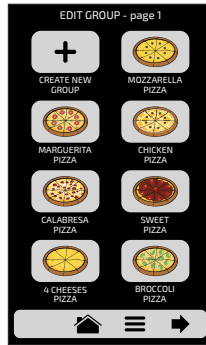



c) The available options after choosing between editing or creating a group will be:

 **Edit Name:** changes the group's name, you may use letters, numbers or special characters.

 **Edit Image:** changes the image the group icon takes.

 **Delete Group:** deletes all the information of the selected group, including the recipes.

 **Delete Recipes:** deletes the previously selected recipes.

 **Order:** orders the location in which the group appears among the existing groups.

 **Change Group Temperature:** changes the preheating temperature group.

## EDIT NAME

a) When selecting the Edit Name option, the following screen will be presented:

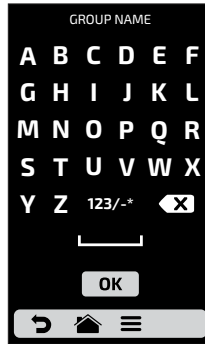

b) Clicking on **123/-\*** and **ABCDE** the screen will toggle between letters and numbers/special characters.

 Deletes a character;

 Space bar;

 Saves the name and returns to the options.





## EDIT IMAGE

a) **Forza STi** has an image gallery that enables the user to change the images of the groups. Press the  icon.

b) A screen with an image library will be presented, browse through the images and select the desired image. It is also possible, instead of adding an image, to maintain the first letter of the group name as the group icon, just click on the ABC icon.

*For example: if your group is called PIZZAS, on the group screen, Snacks will have letter 'P' as its icon.*

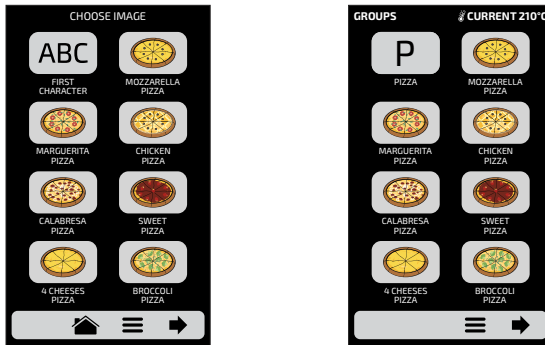

## DELETING RECIPES

a) The deleting recipes option will enable you to delete only the recipes of the previously selected group. Press the button . On the next screen, it will be possible to delete a selection of recipes, or all the recipes:

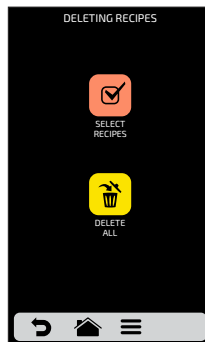

**b) Select Recipes:**



Select the recipes you wish to delete, the **X** will indicate the selected ones, and then click on the trash can of the fixed bar  .



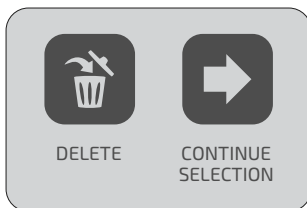
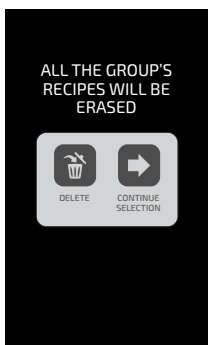

**c) The opposite message will appear - To confirm the exclusion of the recipes, click on the icon 'DELETE SELECTION';**

To continue selecting, click on 'CONTINUE SELECTION':



#### d) Delete All:

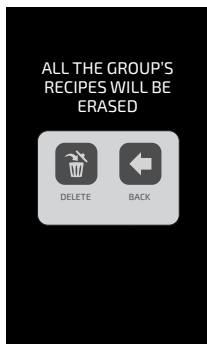

When clicking on the Delete All icon, the following message will be presented:

- To confirm, click on  or, to cancel, and return click on .



### DELETE GROUP

**a) ATTENTION:** When choosing the option of deleting the group, all the information referring to the group will be lost: recipes, steps and other information. And in case the user does not perform a Backup (see page 37, USB Options), it will not be possible to recover this information.

**b)** Press the button  to confirm your choice, or  to return to the options screen.

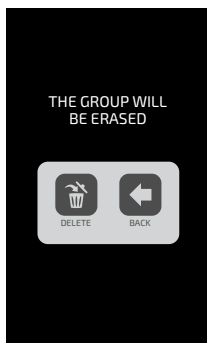

## ORDER

a) The Order function , enables to change the sequence in which the groups will appear on the groups screen.

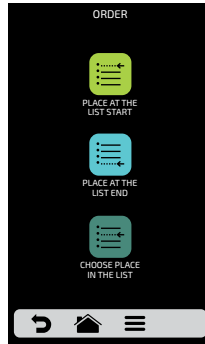

This screen is composed by three buttons:



**Place at the list start:** The group is moved to the beginning of the groups list.



**Place at the list end:** The group is moved to the end of the groups list.



**Choose place in the list:** The operator will be directed to the groups screen to choose the location he/she wants.

b) According to adjacent screen, if the chosen group at the beginning of the editing process is BROCCOLI PIZZA, and the user wishes to place it before MARGUERITA PIZZA, just click on the MARGUERITA PIZZA icon. **Observe by the example that the origin and destination location are not replaced, the software just reorders the groups.**

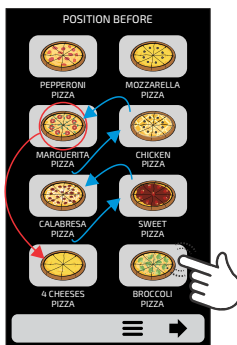

CHOOSE LOCATION IN THE LIST: BEFORE

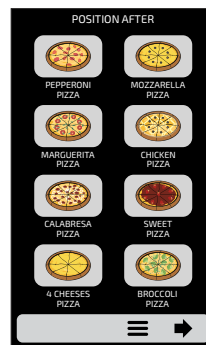

CHOOSE LOCATION IN THE LIST: AFTER

## CHANGE GROUP TEMPERATURE

a) Choose the desired preheating temperature to the selected group.

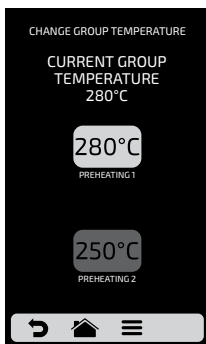





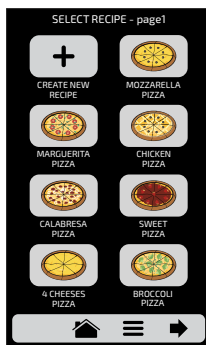
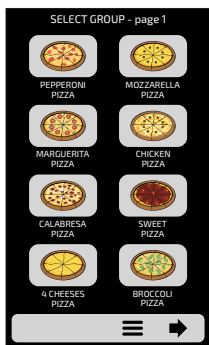

## USER'S SETTINGS: EDIT RECIPES

a) To edit the recipes, touch on the icon  . The groups screen will be displayed. Choose in which group you wish to change the recipes.

b) When accessing the recipes, it will be possible to edit an already existent one or create a new recipe.



c) The available options after choosing between editing or creating a recipe will be:

-  **Edit Name:** changes the name of the recipe, you may use letters, numbers or special characters.
-  **Edit Image:** changes the image the recipe icon takes.
-  **Edit Steps:** accesses the options for edition of the steps of the selected recipe.
-  **Delete Recipe:** deletes all the information of the selected recipe, including the steps.
-  **Order:** orders the location in which the recipe appears among the other recipes of the group.
-  **Brown More:** Changes the time of Brown More function.
-  **Add/Remove from Favorites:** Adds or removes the recipe in the Favorites list.

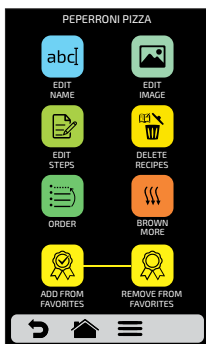

## EDIT NAME

a) When selecting the Edit Name option, the following screen will be presented:



b) Clicking on **123/- \*** and **ABCDE** the screen will swap between letters and numbers/special characters.

 Deletes a character;

 Space bar;

**OK** Saves the name and returns to the options.



## EDIT IMAGE

a) **Forza STi** has an image gallery that enables the user to change the images of the recipes. Press the icon **ABC** .

b) Browse through the icons of the image library to select the desired icon or press the button to transform the first letter of the recipe name into an icon, as shown in the adjacent example.

c) Use  to return to the recipe editing options.

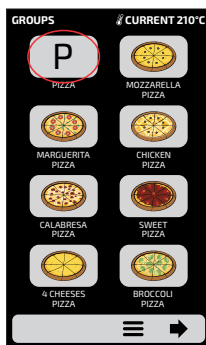
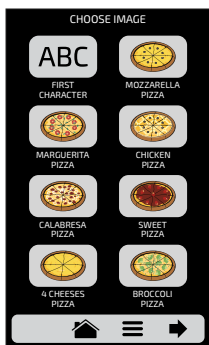

## EDIT STEPS

a) Every recipe supports up to 8 steps. The active steps will appear in green on the Edition screen. The other ones will be transparent, according to the opposite image. Click on a step to edit it.

b) For each step, it is necessary to inform:

- Speed of hot air;
- % of the lower resistance (infra-red);
- Temperature and time.

c) To change the Speed of Hot Air and Lower Resistance (Infra-red), just swipe the finger over the bar of each parameter or click on the desired location.

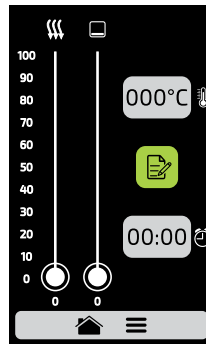
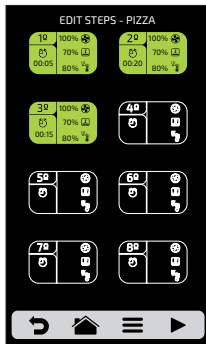

d) To define the time click on the icon .

- A keyboard will appear on the opposite side, define the desired value and click on OK.

e) To define the temperature click on the icon . A keyboard will appear on the opposite side, define the desired value and click on OK.

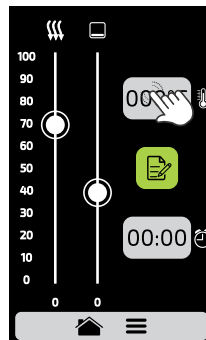
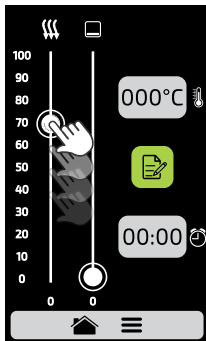





d) Click on the button  to access the options for edition of the step parameters, which are:

e) **Add Information**, which will be displayed at the end of the step during the execution of the recipe. Click on the icon .

f) **Enable and disable the step**: The recipe only executes active steps. When a step is deactivated, it is not deleted, it only remains hidden. **To delete the step, it is necessary to inform the 00:00 value to the time parameter.**

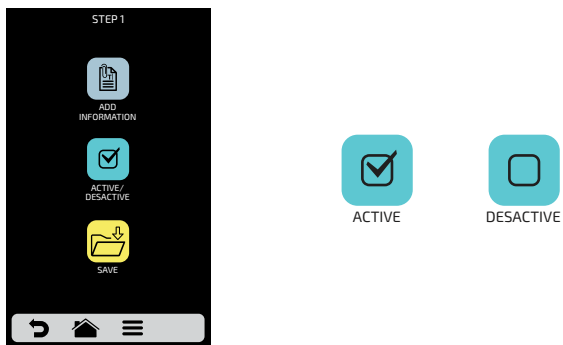
g) After concluding the edition of a step, use  to save and return to the steps screen to edit, create new step, or test the active steps.



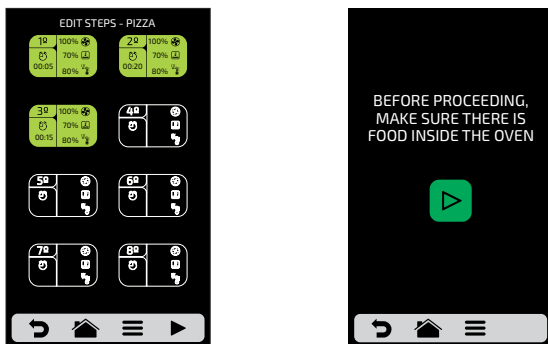

h) To test, click on the icon  that is found in the fixed bar on the steps screen. Before proceeding with the test, make sure that there is food inside the chamber.

i) Use  to return to the recipe editing options.



## DELETING RECIPE

a) Press  to delete the recipe, press the button  to confirm the exclusion or  to return to the options for recipe edition.

## ORDER

a) The Order function , allow to change the sequence in which the groups will appear on the groups screen.



This screen is composed by three buttons:



**Place at the list start:** The recipe is moved to the beginning of the groups list.



**Place at the list end:** The recipe is moved to the end of the groups list.



**Choose place in the list:** The operator will be directed to the recipes screen to choose the location he/she wants. according to adjacent example, if the chosen recipe at the beginning of the editing process is 'PIZZA BRÓCOLIS' and the user wishes to place it before 'PIZZA MARGUERITA', just click on the icon of the desired location.

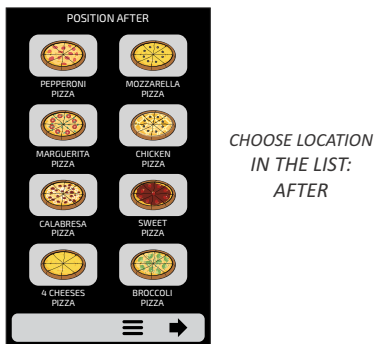
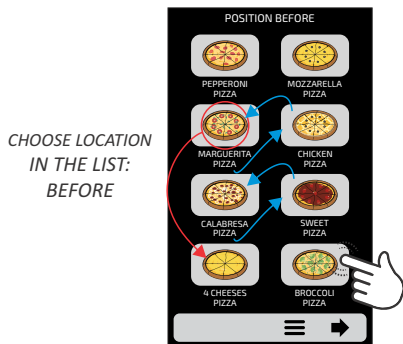



## EDIT BROWN MORE

a) The Brown More function is defined by recipe, that is, it is not a fixed value for all of them, the user may define the time desired for each one of the options.

### Remember that:

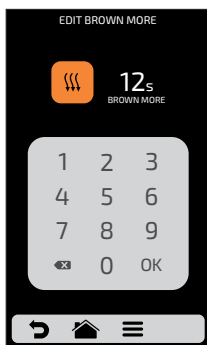
**Brown More** - Only activates HOT AIR.



b) To define the time, just click on the icon  or on the value location, as the indications on the screen show.

c) Use the number pad to inform the time and click on OK.

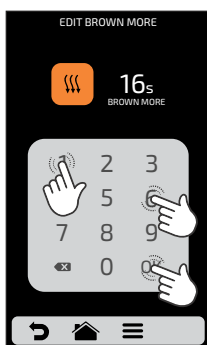



d) The Brown More function may be disabled in the Settings of Edit Accesses (**see page 41**).



e) Use  to return to the recipe editing options.

## ADD / REMOVE FROM FAVORITES

a) The Favorites function may be accessed through the options screen in the fixed bar. However, it will be explained in detail on **page 43**.

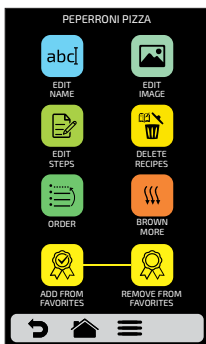
b) To add the recipe to the favorites, click on the icon . A small ribbon  will be added in the upper left corner of the recipe icon.



c) To remove the recipe from the favorites, just do the same process. In the recipe edition options screen, the Remove from Favorites icon will appear: , when clicking on it, the ribbon  will disappear from the icon and the recipe will be removed from the Favorites list.

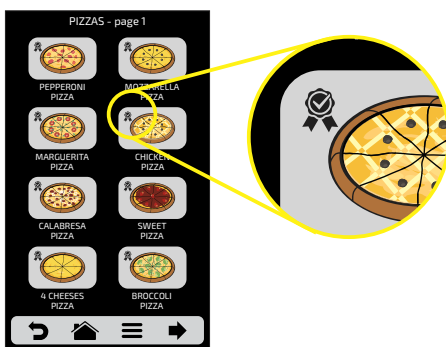



d) Use  to return to the user editing options.



## USER SETTINGS: PREHEAT

a) The editable parameters in Preheat are:

- **Temperature Preheating 1.**
- **Temperature Preheating 2.**
- **Preheating Time:** Define the time of the stopwatch of the Preheating screen.

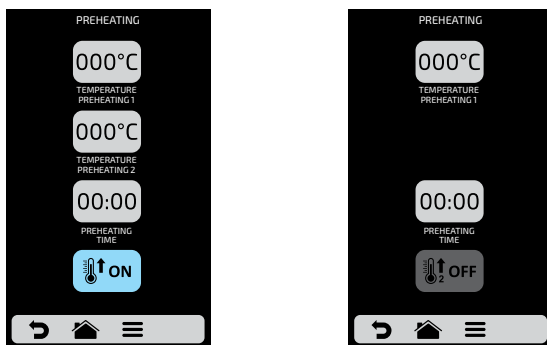
b) The  /  button enables/disables **Preheating 2**. When disabled, all settings related to Preheating 2 are hidden.



c) To edit the values, click on the icons  and  to change the value using the number pad beside.

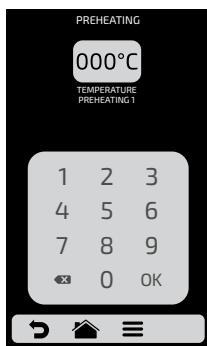

d) Use  to return to the user editing options.

## USER SETTINGS: USB



Access to the USB Port

a) Press the button  . The functions available in USB are: Import, Export and Update System.

b) When selecting one of the functions, the message: *'Insert USB disk and wait for recognition'* will appear.

c) After the recognition, the user will be taken to the function options previously chosen.

- **Import:** All, Groups or Settings.
- **Export:** All, Groups or Settings.
- **System Update.**

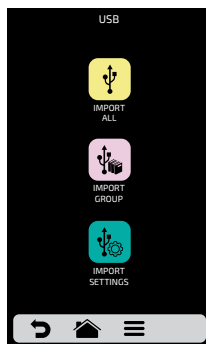
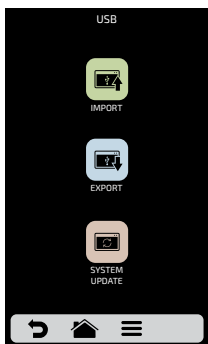



d) In case of error, the displayed message will be: There was an error during the Import/Export/Update. Please remove USB disk and restart process.

e) Use  to return to the user editing options.

## USER SETTINGS: LANGUAGE

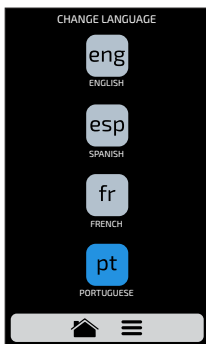
a) To change the language, just click on the icon  and choose the desired language. **English, Spanish, French or Portuguese.**



b) Use  to return to the user editing options.

## USER'S SETTINGS: CURRENT TEMPERATURE

a) The Current Temperature screen  : is only informative. In it, it is possible to verify the temperature of both heating elements: top and bottom heaters.

b) Use  to return to the user editing options.

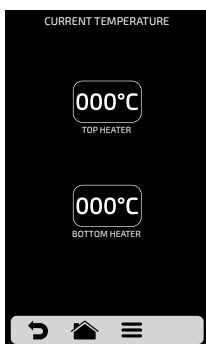

## USER SETTINGS: DATE/TIME ADJUSTMENT

a) It is possible to adjust the Date, Time and format it must be presented to the user, respecting the following standards:

**European:** dd/mm/yyyy



**American:** mm/dd/yyyy

**ISO:** yyyy/mm/dd

**Time:** 24h Format

12h Format

b) Click on  and  to edit, respectively, the date and time.

c) Press  to change the date/time format. The opposite screen will be displayed. Choose the date and time format and click on  to confirm and return to the options.

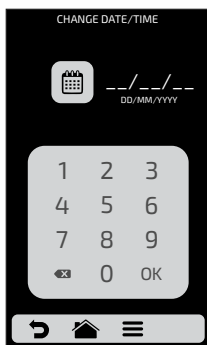
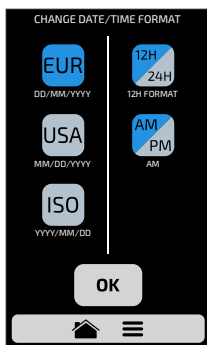



d) Use  to return to the user editing options.

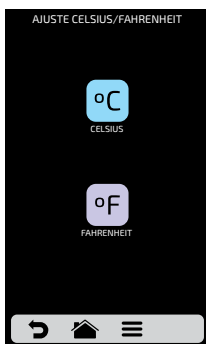

## USER SETTINGS: CELSIUS/FAHRENHEIT

a) Change the temperature format displayed in the oven between Celsius and Fahrenheit, Click on the icon  inside de user settings, and set the temperature format you wish.





b) Use  to return to the user editing options.

## USER SETTINGS: CHANGE PASSWORD

a) To change the user password, just type the new password and then confirm it.

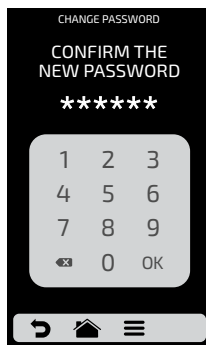
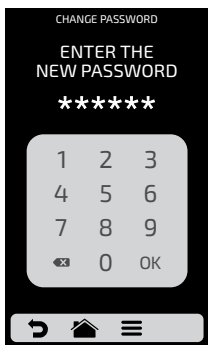
b) In case you forget the password, contact Technical Support.



c) Use  to return to the user settings options.

## USER SETTINGS: EDIT ACCESS

a) Edit Access  corresponds to the function in which you may block functions to the operator.

*For example: If you desire that the Favorites and Manual Mode functions are never accessed by the operators, just click on both of them, which will turn dark gray, indicating that they are locked until the moment you desire to unlock them.*

b) To unlock, just click on the desired functions once more.

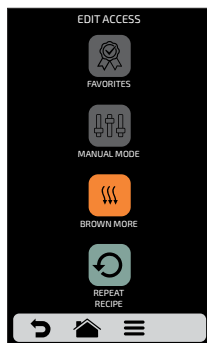
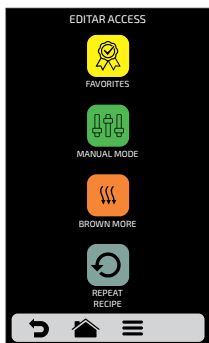

c) Use  to return to the user editing options.

## USER SETTINGS: MANUFACTURER INFORMATION

a) Information on Firmware Version, Serial and Manufacturing Date of the **Forza STI** are contained.



b) Use  to return to the user editing options..

## USER SETTINGS: TECH SUPPORT



a) In the Tech Support information, you will find all the necessary data to contact **Pratica** to clear out questions, request repairs or technical visits



b) Use  to return to the user editing options.

## USER'S SETTINGS: RESTORE FACTORY SETTINGS

a) **ATTENTION:** The Restore Factory Settings option will delete all the Groups, Recipes and their Steps, besides the Settings defined by the user. Make sure to create a Backup through USB before proceeding. After inserting the password and touching **OK: IT IS NOT POSSIBLE TO RECOVER THE INFORMATION.**

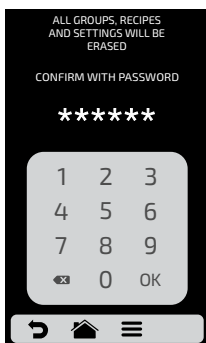

b) Use  to return to the user editing options.

## FAVORITES

a) The Favorites functionality works as a bypass, in which you may allocate the main and most utilized recipes. To access it, just press the Options button  in the fixed menu bar.

b) After opening the Options screen, touch the icon  .

c) Browse through the recipes using the arrows:  /  .

d) See how to Add or Remove a recipe from the Favorites list on [page 35](#).

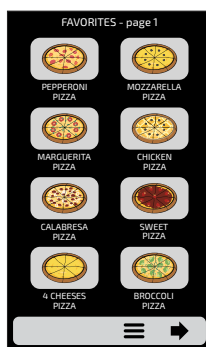
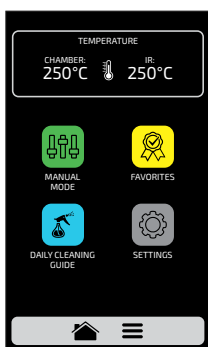

## SOUND ALARMS



- At the end of a recipe the alarm will sound indicating the end of the operation.





- If the oven door is open for more than 30s the alarm will sound alerting the user



- **Caution:** If the alarm signal sounds continuous, the equipment is malfunctioning. Turn off or disconnect from the power supply and check the instruction manual before operating.

## MANUAL MODE

a) In Manual Mode, it is possible to define the parameters of the step, execute it, and if the result of your test is approved, at the end of the operation, transform it in Recipe.

b) To access the Manual Mode, click on the Options button . In the Options screen, touch the icon .

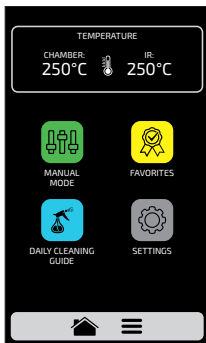

c) Define the parameters of Time, Temperature, Speed of Hot Air and of the Bottom Heater (Infra-red).

d) Press the button  to start the operation of Manual Mode.

e) After the conclusion of the operation, the Copy Parameters icon will be enabled: .

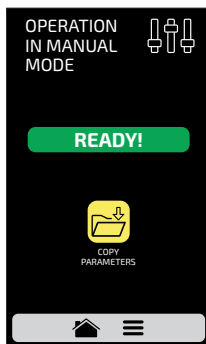
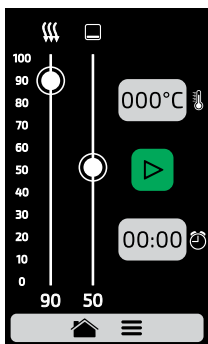

f) Copy Parameters enables the user to transport the parameters defined in Manual Mode for the Edition of Groups and Recipes, that is, when click on the  icon ,it will be necessary to inform the user's access password to the settings

g) After informing the user's password, choose between creating a new group or allocating the transported parameters in a new recipe in an already existent group.

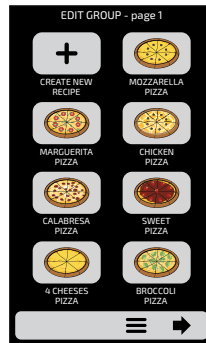
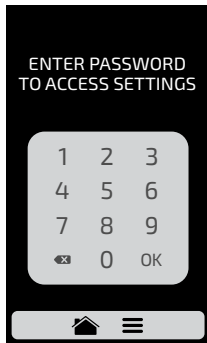

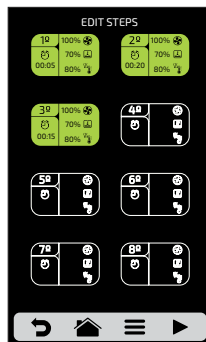

h) Define the name of the New Recipe, the Image and choose in which position (step) you wish to allocate the transported information.

i) To finalize, if you wish, define the other steps of the recipe.



## DAILY CLEANING GUIDE

a) To help in the sanitation of the **Forza STi**, use the Daily Cleaning Guide, access it through the Options screen, click on the Options icon , and then press the button , follow the steps informed on the screen carefully.

1



OPEN THE OVEN DOOR AND WAIT FOR THE TEMPERATURE TO DROP UNTIL 150°F



174°F



Open the oven door and wait for the temperature to drop until 150°F. Proceed clicking on the arrow: ➡

2



REMOVE THE COOK RACK AND BOTTOM JET PLAT AND PLACE IN THE SINK

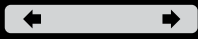

Remove the cook rack and bottom jet plat and place in the sink. Proceed clicking on the arrow: ➡

3



APPLY THE OVEN CLEANER TO THE COOKING RACK AND JET PLATE, ALLOW TO STAND

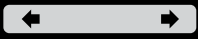

Apply the Oven Cleaner to the cooking rack and jet plate, allow to stand. Proceed clicking on the arrow: ➡

4



APPLY THE OVEN CLEANER TO CAVITY WALLS AND DOOR, LET STAND FOR 5 MINUTES



4min 5s



Apply the Oven Cleaner to cavity walls and door, let stand for 5 minutes. Proceed clicking on the arrow: ➡

5



USE A NON-ABRASIVE SCRUB PAD TO LOOSEN ANY STUBBORN STAINS IF NECESSARY.



Use a non-abrasive scrub pad to loosen any stubborn stains if necessary. Proceed clicking on the arrow: ➡

6



WIPE/RINSE THE CAVITY WITH A WET TOWEL REMOVING CLEANER AND DEBRIS



Wipe/Rinse the cavity with a wet towel removing cleaner and debris. Proceed clicking on the arrow: ➡

## DAILY CLEANING GUIDE

7



APPLY VINEGAR TO THE CHAMBER WALLS AND THE OVEN DOOR TO NEUTRALIZE THE CLEANING PRODUCT



Apply vinegar to the chamber walls and the oven door to neutralize the cleaning product. Proceed by clicking on the arrow: ➡

8



CLEAN / RINSE THE CAVITY WITH A DAMP CLOTH



Clean / Rinse the cavity with a damp cloth. Proceed by clicking on the arrow: ➡

9



DRY THE OVEN CAVITY WITH A TOWEL



Dry the oven cavity with a towel. Proceed clicking on the arrow: ➡

10



USE A NON-ABRASIVE SCRUB PAD TO LOOSEN ANY STUBBORN STAINS ON THE COOK RACK AND JET PLATE IF NECESSARY



Use a non-abrasive scrub pad to loosen any stubborn stains on the cook rack and jet plate if necessary. Proceed clicking on the arrow: ➡

11



CHECK THE CATALYTIC CONVERTER POSITION

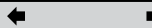

Check the Catalytic Converter position. Proceed clicking on the arrow: ➡

12



RINSE AND DRY RACK AND PLATE, RE-INSTALL THEM INTO THE OVEN CAVITY



Rinse and dry rack and plate, re-install them into the oven cavity. Proceed clicking on the arrow: ➡

b) The last screen will show “Cleaning Complete”, finish by clicking on the arrow: ➡



## CATALYTIC CONVERTER CLEANING GUIDE

**a)** To have access to catalytic converter, remove the stone, the grid and removable lower tray from the oven.

**b)** Then, remove the catalytic converter with an upward movement, as in the image:

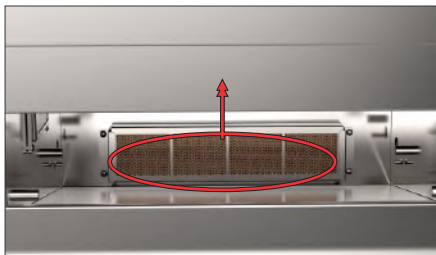

**c)** To sanitize correctly, soak the catalytic converter in warm water with neutral detergent.

**d)** After 15 minutes in the solution, rinse well and install again.

## AIR FILTER CLEANING GUIDE

**a)** To access the air filter, pull it out on the side of the oven.

**b)** Then remove the filter by moving it backwards, as shown in the image:



**c)** To clean properly, soak the filter in warm water with mild detergent.

**d)** After 15 minutes in the solution, rinse well and install again.

## DOOR GLASS CLEANING GUIDE

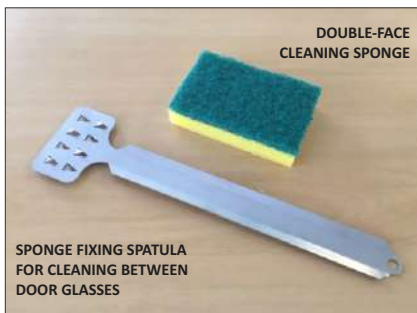

## ALERTS AND ERRORS: POSSIBLE SOLUTIONS

a) The **Forza STi** was programmed to signal any possible error and alerts that may occur during the operation.

b) On the Options icon  , a yellow signal will appear for alerts (  ) and red for errors (  ).

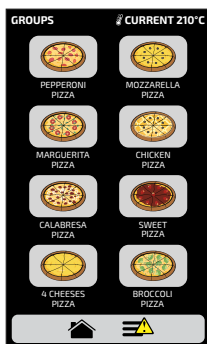

See how to proceed in each case below:

### ALERTS

a) Click on the Options icon  .

b) The Options screen will bring, instead of the top and bottom heaters temperatures, a description of the alert.

In the adjacent example:

### ALERT - CHAMBER SENSOR FAILURE

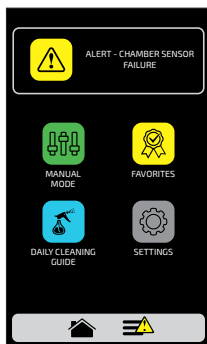

c) Follow the orientation as described on the screen. In this case, turn off and turn on the oven again using the panel button:

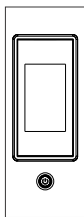

d) After turn on the equipment, if the fault persists, call the Technical Service.

## ERRORS

a) In case of several unsuccessful reset attempts, the alert will become an error, and it will be necessary to contact Technical Support. Whenever an error occurs, an sound alarm will play along with the symbol (  ) on the screen.

b) Refer to the table on the next screen to verify the possible errors and alerts.

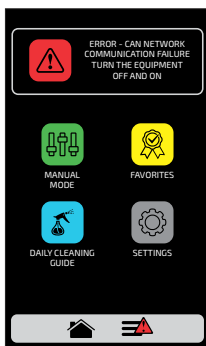

## ALERTS AND ERRORS TABLE

Component	Becomes Alert when:	Becomes Error when:	Error Sound Alarm
Inverter	-	more than ten reset attempts	On
CLMG Low Magnetron Current	fifteen seconds without reaching the current	-	On
Can Network Communication	-	cables disconnected or faulty	On
Chamber Sensor and IR	only one inactive	both inactive	On
Panel temperature	from 65 °C to 80 °C	exceeding 80 °C for 10 minutes	On

You can call our technical assistance to provide feedback, offer suggestions, or get technical assistance during normal business hours at: +1.214.584.6269.







*Prática*  
TECHNICOOK