

# eikon<sup>®</sup> e3 e4 e5

## Installation and Operating Instructions



### **IMPORTANT INFORMATION - READ BEFORE USE**

Users are cautioned that maintenance and repairs should be performed by a Merrychef<sup>®</sup> authorized service agent using genuine Merrychef<sup>®</sup> replacement parts. Merrychef<sup>®</sup> will have no obligation with respect to any product that has been improperly installed, adjusted, operated or not maintained in accordance with national and local codes or installation instructions provided with the product, or any product that has its serial number defaced, obliterated or removed, or which has been modified or repaired using unauthorized parts or by unauthorized service agents. For a list of authorized service agents, please refer to the back page of this booklet. The information contained herein (including design and parts specifications) may be superseded and is subject to change without notice.

# INTRODUCTION

Merrychef® eikon® ovens offer operators the flexibility of combination cooking with additional control over fan speed and microwave power.

Combination cooking enables high quality results to be achieved in a fraction of the time taken by conventional cooking, particularly when baking, browning, roasting and grilling dishes.

Once established, precise instructions for combination or convection cooking of selected items may be programmed into the oven's memory so that they can be repeated easily and accurately. Up to 1024 programs can be stored and simply recalled.

## Multistage Programming

The oven controls offer even greater flexibility by allowing multistage programming. This enables the exact conditions required for quality results to be set according to the food type.

A single cooking program can have up to 6 stages, each stage controlled with its own time, fan speed and microwave power settings (model dependent).

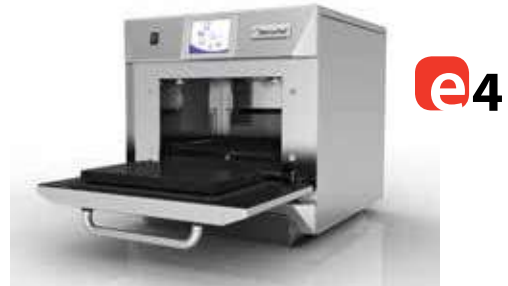

*Merrychef®, eikon® and MenuConnect® are registered US trademarks of The Manitowoc Company Inc. Press&GO® and easyToUCH® are registered US trademarks of Convotherm®, a brand of The Manitowoc Company Inc.*

*All other company names and product names mentioned herein are trademarks or registered trademarks of their respective owners.*



### PRECAUTIONS TO AVOID POSSIBLE EXPOSURE TO EXCESSIVE MICROWAVE ENERGY

- Do not attempt to operate this oven with the door open since open-door operation can result in harmful exposure to microwave energy. It is important not to defeat or tamper with the safety interlocks.
- Do not place any object between the oven front face and the door or allow soil or cleaner residue to accumulate on sealing surfaces.
- Do not operate the oven if it is damaged. It is particularly important that the oven door closes properly and that there is no damage to the (1) door (bent) (2) hinges and latches (broken or loosened) (3) door seals and sealing surfaces.
- The oven should not be adjusted or repaired by anyone except properly qualified service personnel.

### SYMBOLS USED FOR SAFETY INSTRUCTIONS

Safety instructions are categorised according to the following hazard levels:



#### DANGER!

► Immediate risk of death/serious injury (irreversible)



#### WARNING

► Potential risk of death/serious injury (irreversible)



#### CAUTION

► Potential risk of minor injury (reversible)

#### NOTICE

► Potential risk of damage to property (reversible)



#### WARNING

**THIS IS A CLASS A PRODUCT. IN A DOMESTIC ENVIRONMENT THIS PRODUCT MAY CAUSE RADIO INTERFERENCE IN WHICH CASE THE USER MAY BE REQUIRED TO TAKE ADEQUATE MEASURES.**

The instructions outlined in this guide are intended to ensure the safety and long life of your Merrychef® eikon® oven.

**PLEASE READ THE FOLLOWING SAFETY INSTRUCTIONS CAREFULLY**

INTRODUCTION	2
WARNING	2
<b>SAFETY &amp; REGULATIONS</b>	
IMPORTANT SAFETY INSTRUCTIONS	4
PRECAUTIONS TO BE OBSERVED	6
SUITABLE COOKING UTENSILS	6
<b>PRODUCT DETAILS</b>	
MAIN FEATURES	7
TECHNICAL SPECIFICATIONS	8
Specifications	8
Serial Number (Rating Plate)	8
Compliances	8
INSTALLATION	10
ELECTRICAL INSTALLATION	11
<b>OPERATION &amp; CONTROLS</b>	
QUICK START GUIDE: QUICK SERVICE OVEN	13
START UP	13
USING A COOKING PROGRAM	14
OPERATING GUIDE: FULL SERVICE OVEN	15
easyToUCH® MAIN MENU & KEYBOARD SCREEN	15
DEVELOPMENT MODE: CREATING A COOKING PROGRAM	16
Press&GO®	17
USING A COOKBOOK PROGRAM	17
CHANGING THE OVEN TEMPERATURE	18
VIEWING & EDITING COOKING PROGRAMS	18
ADDING A NEW PROGRAM GROUP	19
MOVE A COOKING PROGRAM WITHIN A PROGRAM GROUP	19
ADDING A COOKING PROGRAM TO A PROGRAM GROUP	20
MANAGING PROGRAM GROUPS	20
OVEN CONTROL SETTINGS	21
Oven Mode/Navigation Settings (A)	21
Language Options (B)	21
Oven Temperature Settings and Labels (C)	21
Service Information & Error Logs (D)	21
Recipe Counters (E)	22
Date and Time Settings (F)	22
Sound Levels (G)	22
Oven Timer (H)	22
USB Oven Programs (J)	23
Temperature Band (K)	23
Change Password (L)	23
Screen Saver (M)	23
<b>CLEANING &amp; MAINTENANCE</b>	
COOLING THE OVEN DOWN BEFORE CLEANING	24
Oven cool down	24
Preparing to clean the oven	24
Cold oven CLEANING INSTRUCTIONS e3	25
Cold oven CLEANING INSTRUCTIONS e4	26
Cold oven CLEANING INSTRUCTIONS e5	27
<b>FAULT FINDING</b>	
FAULT FINDING CHART	28
SERVICING	29

## IMPORTANT SAFETY INSTRUCTIONS

When using electrical appliances basic safety precautions should be followed, including the following:

**WARNING:** To reduce the risk of burns, electric shock, fire, injury to persons, or exposure to excessive microwave energy:

1. Read all instructions before using the appliance.
2. Read and follow the specific 'PRECAUTIONS TO AVOID POSSIBLE EXPOSURE TO EXCESSIVE MICROWAVE ENERGY' found on the Introduction page.
3. This appliance must be grounded. Connect only to a properly grounded outlet. See 'ELECTRICAL INSTALLATION'.
4. Install or locate this appliance only in accordance with the provided installation instructions.
5. **WARNING:** Liquids or other foods must not be heated in sealed containers since they are liable to explode.
6. Use this appliance only for its intended use as described in the manual. Do not use corrosive chemicals or vapours in this appliance. This type of oven is specifically designed to heat, cook or dry food. It is not designed for industrial or laboratory use.
7. This appliance should not be used by children.
8. If the supply cord is damaged, it must be replaced by the manufacturer, its service agent or similarly qualified persons in order to avoid a hazard.
9. **WARNING:** it is hazardous for anyone other than a competent person to carry out any service or repair operation that involves the removal of any cover which gives protection against exposure to microwave energy.
10. Do not cover or block any openings on

the appliance including air vents/filters and steam outlet.

11. Do not store this appliance outdoors. Do not use this product near water — for example, near a kitchen sink, in a wet basement, or near a swimming pool, and the like.
12. Do not immerse the power cord or plug in water.
13. Keep the cord away from heated surfaces.
14. Do not let the cord hang over an edge of a table or counter.
15. Either:
  - i) When cleaning surfaces of door and oven that come together on closing the door, use only mild non-abrasive soaps, or detergents applied with a sponge or soft cloth.
  - ii) When separate cleaning instructions are provided, see door surface cleaning instructions.
16. To reduce risk of fire in the cavity:
  - i) When heating food in plastic or paper containers, keep an eye on the oven due to the possibility of ignition.
  - ii) Remove wire twist-ties from paper or plastic bags before placing bag in oven.
  - iii) If materials inside the oven should ignite, keep oven door closed, turn oven off, and disconnect the power cord, or shut off power at the fuse or circuit breaker panel.
  - iv) Do not use the cavity for storage purposes. Do not leave paper products, cooking utensils or food in the cavity when not in use.
17. **WARNING:** Microwave heating of beverages can result in delayed eruptive boiling therefore care must be taken when handling the container.

### SAVE THESE INSTRUCTIONS

## IMPORTANT SAFETY INSTRUCTIONS

---

18. DO NOT operate using microwave only or combination function without food or liquid inside the oven as this may result in overheating and may cause damage.
19. NEVER remove the exterior of the oven.
20. NEVER remove any fixed internal parts of the oven.
21. NEVER tamper with the control panel, door, seals, or any other oven part.
22. DO NOT obstruct air vents/filters or steam outlet.
23. NEVER hang dish towels or cloths on any part of the oven.
24. WARNING: If the door or door seals are damaged, the oven must not be operated until it has been repaired by a competent person.
25. If the power cable is damaged in any way it MUST be replaced by an approved Service Agent.
26. When handling hot liquids, foods, and containers, care should be taken to avoid scalds and burns.
27. When heating liquids using microwave only or combination function, the contents should be stirred prior to heating to avoid eruptive boiling.
28. WARNING: The contents of feeding bottles and baby food jars must be stirred or shaken and the temperature checked before consumption in order to avoid burns.
29. Never use the oven to heat alcohol, e.g. brandy, rum, etc. Food containing alcohol can more easily catch fire if overheated, observe caution and do not leave the oven unattended.
30. Never attempt to deep fry in the oven.
31. This appliance is not intended for use by persons (including children) with reduced physical sensory or mental capabilities, or lack of experience and knowledge, unless they have been given supervision or instruction concerning use of the appliance by a person responsible for their safety.
32. Children should be supervised to ensure that they do not play with the appliance.
33. Oven must not be operated without the air filter in place.
34. The minimum height of free space necessary above the top surface of the oven is 50mm (2Ins).
35. Only use utensils that are suitable for use in microwave ovens.
36. If smoke is observed, switch off or unplug the appliance and keep the door closed in order to stifle any flames.
37. The oven should be cleaned regularly and any food deposits removed.
38. Failure to maintain the oven in a clean condition could lead to deterioration of the surface that could adversely affect the life of the appliance and possibly result in a hazardous situation.
39. The appliance should not be cleaned with a water jet.

## SAVE THESE INSTRUCTIONS

## PRECAUTIONS TO BE OBSERVED

1. Read this manual before using your oven.
2. As with all electrical appliances, it is wise to have the electrical connections inspected at least once a year.
3. The oven interior, door seals should be cleaned frequently, following the instructions described in the cleaning section, failure to do so could possibly result in a hazardous situation.
4. Switch off the oven at the end of all the cooking sessions for that day.
5. The oven should not be used to dry linen.
6. As with any cooking appliance, care should be taken to avoid combustion of the items within the oven.
7. Food in combustible plastic or paper containers should be transferred to a microwave/oven proof containers to avoid the possibility of ignition.
8. Items should be unwrapped when using convection and combination functions.
9. Eggs in their shells and hard boiled eggs should not be heated in microwave ovens since they may explode even after microwave heating has ended.
10. Food with a skin, e.g. potatoes, apples, sausages etc. should be pierced before heating.
11. Food should not be heated in a completely sealed container as the build-up of steam may cause it to explode.
12. Excess fat should be removed during 'roasting' and before lifting heavy containers from the oven.
13. In the event of glass breaking or shattering within the oven, ensure that food is totally free of glass particles. If in doubt, dispose of any food that was in the oven at the time of the breakage.
14. DO NOT attempt to operate the oven with: object caught in door, that does not close properly or damaged door, hinge, latch, sealing surface or without food in the oven.

### IF SMOKE IS OBSERVED:

- Switch off the appliance
- Isolate the appliance from the electrical supply
- Keep the door closed to stifle any flames

## SUITABLE COOKING UTENSILS

Manufacturer's instructions should be checked to determine the suitability of individual containers or utensils using each of the cooking functions. The following chart provides general guidelines:

<b>Heat resistant containers</b>		
Toughened glass Vitreous ceramics Earthenware (porcelain/crockery/china etc.)	✓ ✓ ✓	Do not use items with metallic decoration.
<b>Metallic &amp; Foil Trays</b>		
Metallic trays DO NOT USE ANY OTHER METAL OR FOIL CONTAINERS	✓	Metallic trays may only be used when placed on the VITREOUS RACK in the oven cavity. Do not cook food directly on the vitreous enamel rack.
<b>Plastic containers</b>		
Dual-ovenable plastic containers	✓	(up to certain temperatures) are now available. Check manufacturer's instructions before use.
<b>Disposables</b>		
DO NOT USE Combustibles (paper/card etc.)	✗	
<b>Other utensils</b>		
Tie tags Cutlery Temperature probes	✗ ✗ ✗	No kitchen utensil should be left in food while it is cooking in the oven.

# MAIN FEATURES

## 1 ON/OFF SWITCH

When switched ON the easyToUCH® screen illuminates the oven controls. NOTE: Turning this switch OFF does not isolate the oven from the electricity supply.

## 2 easyToUCH® SCREEN CONTROL PANEL

See 'OPERATION & CONTROLS' for details.

## 3 RATING PLATE

Located on the rear panel of the oven states the serial number, model type & electrical specifications.

## 4 MenuConnect®

A USB socket located under the Merrychef logo allows changes to programs stored on the oven (See USB MenuConnect® User Manual, and 'Operation & Controls' section of this manual, for details of updating oven programs).

## 5 AIR OUTLETS

Air used to cool internal components and steam from the cavity escape through the air outlet vents located on the rear of the oven and side panel of the e5 model. The air outlets must be kept free from obstruction and they will not allow microwave energy to escape into the environment.

## 6 AIR INLET FILTER

The air filter situated at the lower front of the oven is part of the ventilation system and must be kept free of obstruction and cleaned daily as described under 'Cleaning & Maintenance'. NOTE: The oven will not operate without the air filter fitted.

## 7 DOOR HANDLE

This is a rigid bar which is pulled downwards and away from the oven to open.

## 8 OVEN DOOR

This is a precision-made energy barrier with three microwave safety interlocks. The door must be kept clean (see 'Cleaning & Maintenance') and should NOT be used to support heavy objects.

## 9 DOOR SEALS

These ensure a tight seal around the door. They should be kept clean and checked regularly for signs of damage. At the first sign of wear they should be replaced by a Merrychef approved Service Agent.

## 10 CONVECTION FAN, GREASE FILTER & CATALYTIC CONVERTOR (model dependant)

The metal grease filter grill covering the convection fan must be kept clean and free of debris. Great care should be taken when cleaning this area of the oven noting the different oven requirements shown under 'Cleaning & Maintenance' in this manual.

## 11 OVEN CAVITY

The oven cavity is constructed from stainless steel and must be kept clean by following the cleaning instructions in the 'Cleaning & Maintenance' section of this manual.

e3

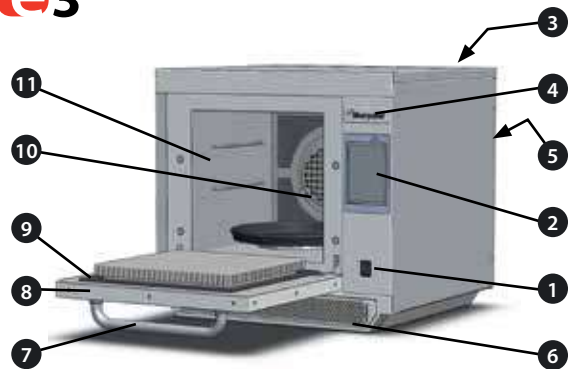

e4

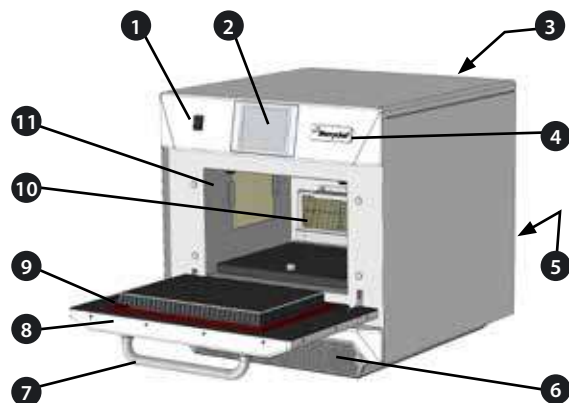

e5

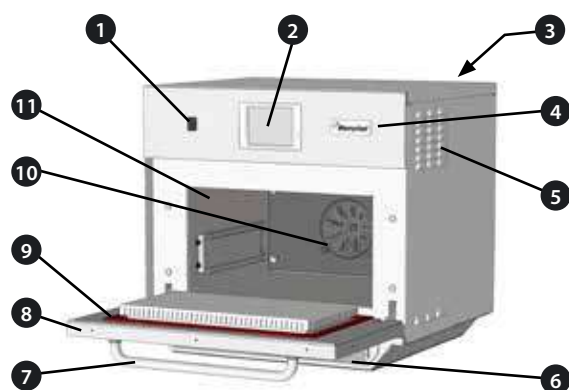

# TECHNICAL SPECIFICATIONS

## Specifications

Description	unit	e3	e4	e5
Touch screen controls	programs	1024	1024	1024
Ambient operating temperature	°C/°F	<40/104	<40/104	<40/104
External HxWxD	mm	551x598x622	591x584x750	642x711x705
External HxWxD	inches	21.7x23.5x24.5	23.3x23.0x29.5	25.3x28.0x27.8
Internal HxWxD	mm	319x332x325	218x375x312	258.4x495x363.5
Internal HxWxD	inches	12.6x13.1x12.8	8.6x14.8x12.3	10.17x19.49x14.31
Cooking chamber	Ltr (cu.ins)	34.4 (2113)	25.5 (1566)	44.4 (2730)
Power output microwave	Watts	700/1000	1500	1400
Power output convection	kW	3 (3/1.5 EE)	3.2	3.2
Power supply	Hz	50 / 60	50 / 60	50 / 60
Power supply	V	230 / 220	230 / 220	230 / 220
Power supply	kW	3(EE) 4.3(XE) 4.7(XX)	6.2	6.2
Unpackaged oven weight net	Kg (lbs)	62.5 (138)	82.5 (182)	94.0 (207)
Sound pressure level	dB(A)	<70	<70	<70

PRODUCT DETAILS

**e3**

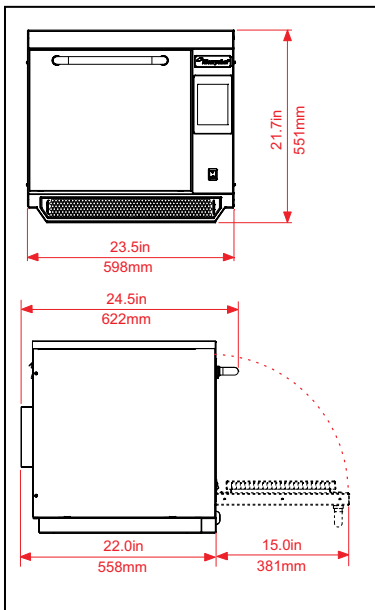

**e4**

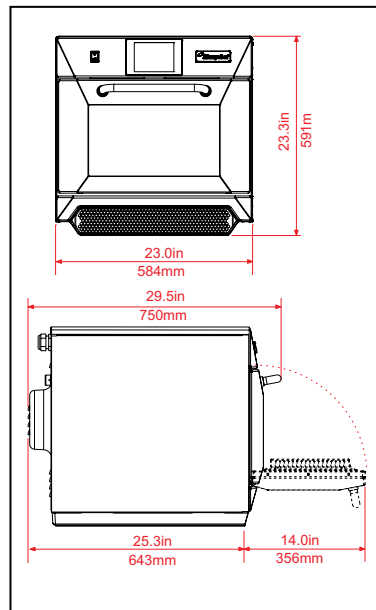

**e5**

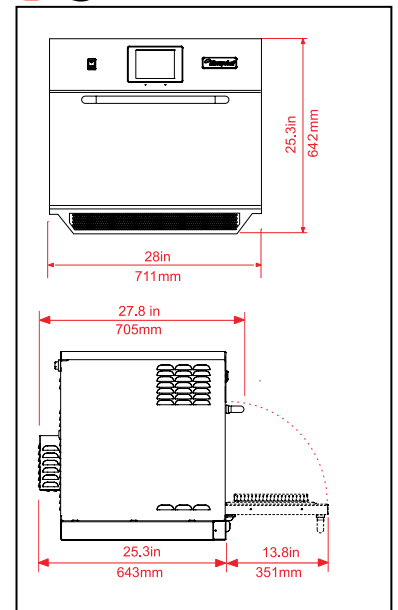

### Serial Number (Rating Plate)

Serial number: YY MM SITE SERIAL

i.e. 10 06 2130 12345 (1006213012345)

Oven manufactured 2013 in June at Sheffield (UK), production number 12345.

Model Number: MODEL, CONVECTION, MICROWAVE, VOLTAGE, HERTZ, LEAD PLUG, COMMUNICATION, VERSION, CUSTOMER/ACCESSORY, COUNTRY

i.e. e4C SV 30 5 H E U 1 GM EU (e4CSV305HEU1GMEU)

model e4C, 3200W, 1500W, 230V, 50Hz, L+N+E(4mm EU), 3-pin plug, USB, 1, General Market, European.

### Compliances

EU Directives

EMC 2004/108/EC

LVD 2006/95/EC

RoHS 2002/95/EC

MD 2006/42/EC





# EC Declaration of Conformity

## Manufacturer

### 1) Brand Headquarters

Welbilt UK Limited  
Ashbourne House,  
The Guildway, Old Portsmouth Road  
Guildford, GU3 1LR

### 2) Production Site

Welbilt UK Limited  
Provincial Park,  
Nether Lane, Ecclesfield,  
Sheffield, S35 9ZX

## Equipment details

### Generic Model Numbers

eikon® e3, eikon® e4, eikon® e5

### Description

Commercial Combination Microwave Oven

## Declaration of Conformity with directives and standards

The manufacturer hereby declares that its commercial combination microwave ovens listed above comply with the following directives and standards.

## Compliance with Directives

The commercial combination microwave ovens comply with the relevant provisions of the following European Directives:

EMC 2004/108/CE      LVD 2006/95/EC      RoHS 2002/95/EC      MD 2006/42/EC

## Harmonised Standards Applied

The commercial combination microwave ovens comply with the relevant requirements of the following European standards:

- EN 60335-2-90: 2006 +A1 (excluding Annex EE ship board requirements)
- EN 60335-1: 2002+A11+A1+A12+A2+A13+A14
- EN 62233:2008
- EN 55014-2:1997 inc A2:2008 in accordance with Category IV requirements
  - Electrostatic discharge IEC 61000-4-2:2009
  - Radiated RF interference IEC 61000-4-3:2006
  - Fast transient common mode, AC port IEC 61000-4-4:2004
  - Mains surge, AC port IEC 61000-4-5:2006
  - RF current, common mode, AC port IEC 61000-4-6:2007
  - Mains voltage dips & interruptions IEC 61000-4-11:2004
- Flicker IEC 61000-3-11:2000
- EN 55011:2007 Classification: Class A, Group 2
  - Mains terminal disturbance voltage Table 6
  - Radiated disturbance, magnetic field\* Table 9
  - Radiated disturbance, electric field Table 9
- AS/NZS CISPR 11
  - Radiated disturbance CISPR 11:2009 Class A
  - Conducted disturbance CISPR 11:2009 Class A

## Quality and environmental management

Welbilt UK Limited (Sheffield) employs a quality management system in accordance with EN ISO 9001:2008 and a certified environmental management system in accordance with EN ISO 14001.

# INSTALLATION

Check for obvious signs of transit damage.

If necessary, inform the freight company IMMEDIATELY.

Remove packing material and protective film from the oven and safely discard.

Included inside your oven:

**Model e3 Series:**

- Handle. Round Trays (x2) + Square Trays (x2).
- Pack option: Round Trays (x3) + Teflon Mats (x3).

**Model e4 Series:**

- Self-supporting Rack
- Vitreous Enamel Tray
- Cool down Rack

**Model e5 Series:**

- Rack. Vitreous Enamel Trays (x2).

## OVEN LOCATION AND POSITIONING

Choose a site away from major heat sources.

DO NOT position so that hot air is drawn in from fryers, grills, griddles, etc.

A heat barrier to the height of the oven must be installed if sited next to a burner, stove or range.

Place the oven on a permanent nonslip/nonflammable flat surface that is LEVEL, STABLE and STRONG enough for the oven and contents.

Allow a minimum clearance (A) of 2 inches (50mm) around the oven for hot air to escape.

Allow sufficient clearance (B), in front of the oven for the door to open fully.

The air intake is located at the lower front of the oven (1) and it is important that the airflow is as cool as possible and not preheated by other appliances such as burners, stoves, ranges, fryers, grills and griddles as this will deteriorate the life and performance of the oven.

Do not affix labels/stickers to oven other than those applied or approved by the manufacturer.



The oven will not operate without the AIR FILTER correctly fitted in place.

## HANDLING & STORAGE

When moving an oven always observe and follow national and local requirements for lifting and moving heavy objects. Do not use the oven door handle to lift oven.

When not in use, electrically disconnect the oven and store safely in a dry cool place, do not stack ovens.

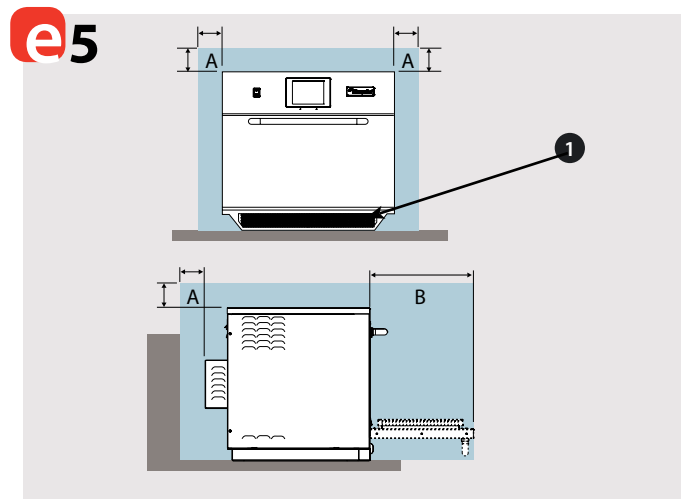
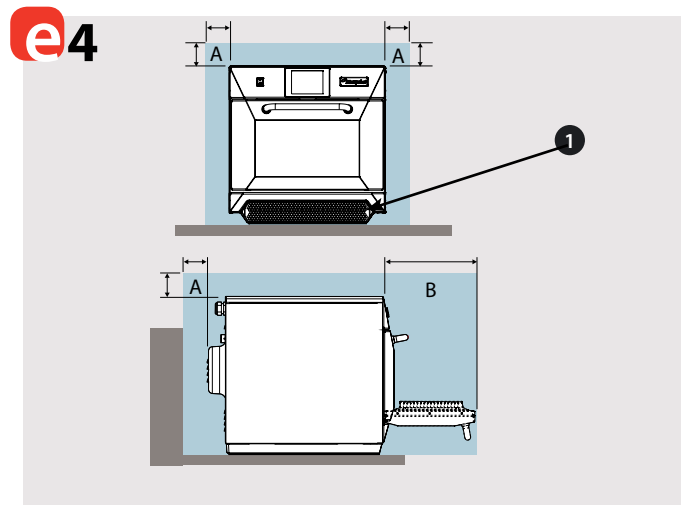
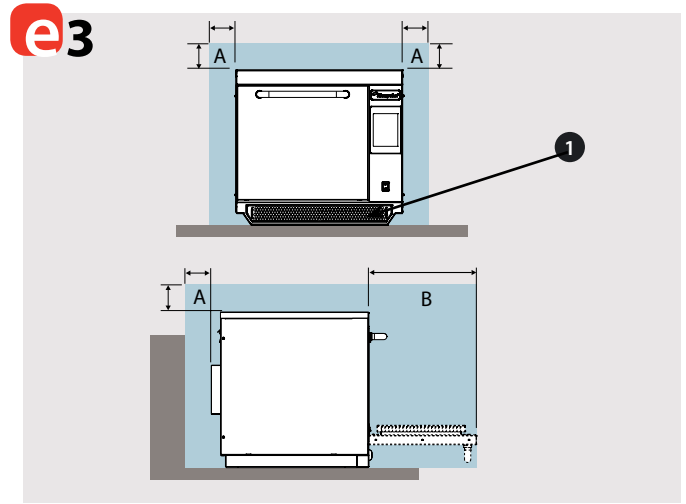

# ELECTRICAL INSTALLATION



**DANGER!**  
THIS APPLIANCE MUST BE EARTHED.  
FAILURE TO DO SO MAY RESULT IN  
ELECTRIC SHOCK AND DEATH.

The oven must be connected to a separate electrical supply installed by a qualified and approved electrician.

A suitably rated isolating switch with a 3mm contact gap on all poles should be fitted for each oven installed.

Establishments with standard (Type 'B') circuit breakers are sensitive to 'surges' which occur on switching on freezers, refrigerators and other catering equipment, including microwave ovens. Because of this, we strongly recommend that a separate Type 'C' circuit breaker (designed specifically for this type of equipment) must be fitted. An individual, suitably rated circuit breaker should be fitted for each oven installed.

This equipment complies with EN61000-3-11, however, when connecting sensitive equipment to the same supply as the oven, the user should determine in consultation with the supply authority, if necessary, that a low impedance supply is used.

## SINGLE PHASE (1)

UK models are fitted with a Blue 32Amp Plug to IEC 60309 (EN 60309)

The Circuit Breaker should be rated at 40A (Type C).

## TWIN PHASE (2)

Twin Phase models should be connected as shown.

The Circuit Breaker should be rated at 20A/Phase (Type C).



**WARNING**  
HIGH LEAKAGE CURRENT -- EARTH  
CONNECTION IS ESSENTIAL.



## EQUIPOTENTIAL

An Equipotential Earth point is provided on the rear panel of the oven for independent Earth (GND) connection.

## POWER SUPPLY: EARTH LEAKAGE CIRCUIT BREAKERS

If the oven is connected to an Earth Leakage Circuit Breaker device, this should allow a minimum of 30 milliamperes earth current without interrupting the circuit.

**IF YOU ARE IN ANY DOUBT ABOUT YOUR  
ELECTRICAL SUPPLY, SEEK THE ADVICE OF A  
QUALIFIED ELECTRICIAN.**

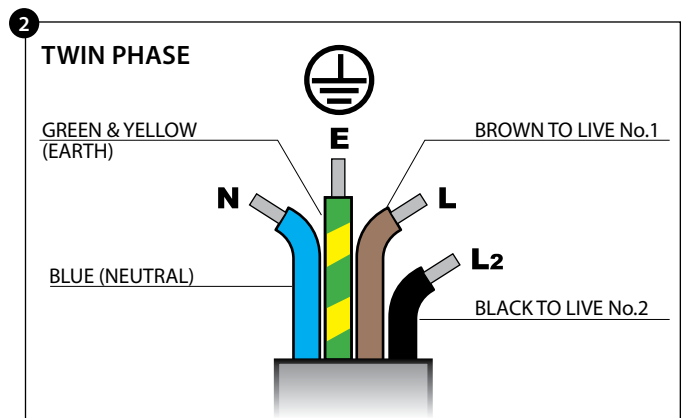
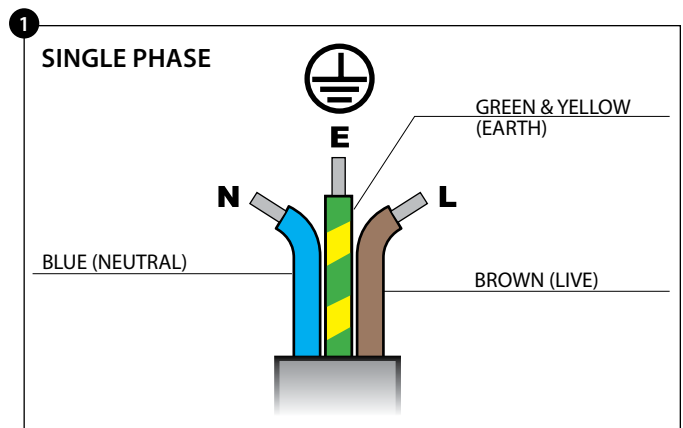

# ELECTRICAL INSTALLATION GUIDE



**DANGER!**  
THIS APPLIANCE MUST BE EARTHED.  
FAILURE TO DO SO MAY RESULT IN  
ELECTRIC SHOCK AND DEATH.

The oven must be connected to a separate electrical supply installed by a qualified and approved electrician.

A suitably rated isolating switch with a 3mm contact gap on all poles should be fitted for each oven installed.



**WARNING**  
HIGH LEAKAGE CURRENT.



## EQUIPOTENTIAL

An Equipotential Earth point is provided on the rear panel of the oven for independent Earth (GND) connection.

PRODUCT DETAILS

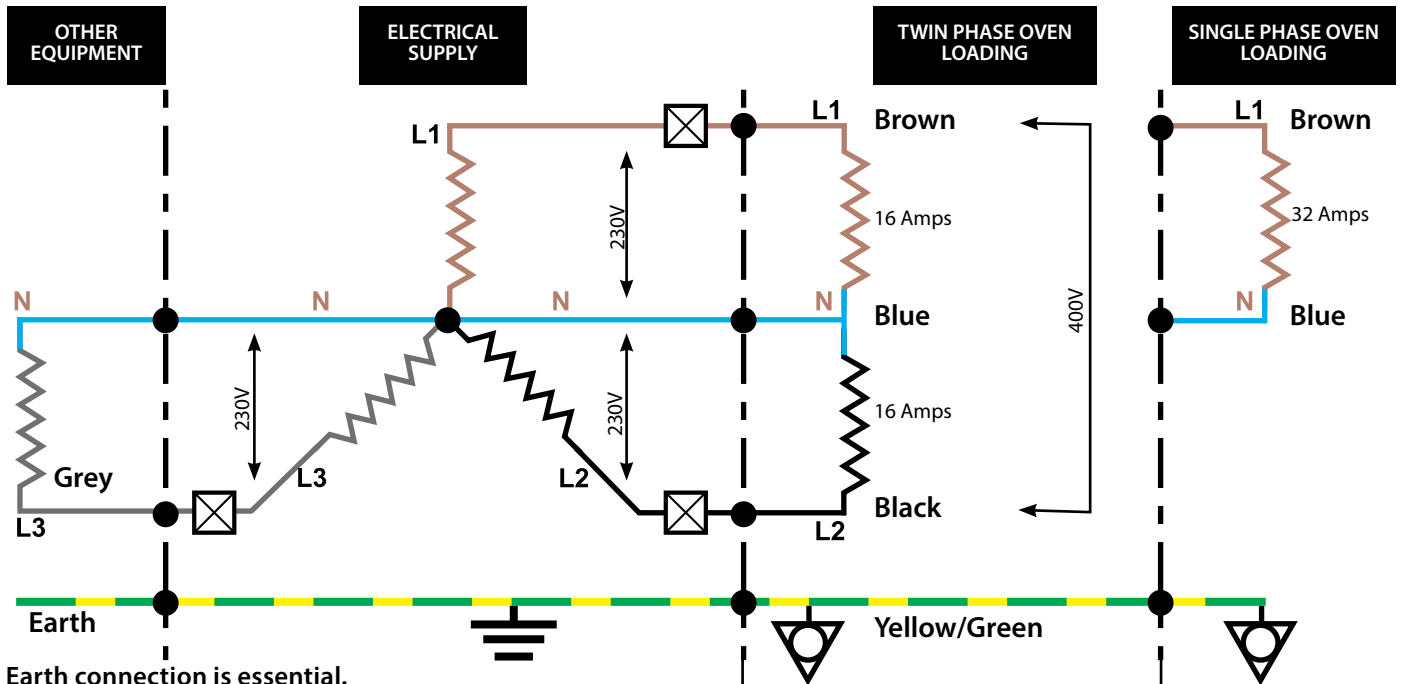

Earth connection is essential.

## Phase Loading Diagram

### PHASE LOADING

Oven loading per phase is not equal therefore we recommend that other electrical equipment is connected to L3+ N.

#### ⊠ Circuit Breakers

##### TWIN PHASE

Circuit Breakers should be rated at 20A per Phase and be Time Delay, Motor Start Type (European Type C).

##### SINGLE PHASE

Circuit Breakers should be rated at 40A per Phase and be Time Delay, Motor Start Type (European Type C).

#### Earth Leakage Circuit:

If the oven is connected to an Earth Leakage Circuit Breaker device, this should allow a minimum of 30 milliamps earth current without interrupting the circuit.

If you are in any doubt about your electrical supply, seek the advice of a qualified electrician.

#### RED

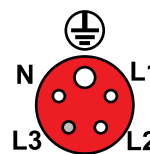

Rear view of plug

Plug Type:

Three Phase

32Amp

IEC 60309

[EN60309]

L1+ L2+ N+ E

[L3 is not used]

20 Amp

#### BLUE

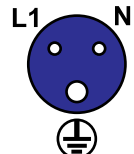

Rear view of plug

Plug Type:

Single Phase

32Amp

IEC 60309

[EN60309]

L1+N+E

40 Amp

# QUICK START GUIDE: QUICK SERVICE OVEN

The easyToUCH® screen display, layout and icons shown herein are for guidance purposes only and are not intended to be an exact representation of those supplied with the oven.

## START UP

1. Switch the oven on on.

Make all the relevant safety checks and ensure the oven is clean and empty before pressing the oven switch down to activate the oven.

2. The easyToUCH® screen illuminates with the display briefly showing the serial number and oven data. If required, to keep the data on the screen, lightly tap the screen once to freeze the display. Tap again to continue.

3. When the oven is setup with two or more preheating temperatures a choice is displayed.

Scroll arrows at the bottom of the screen indicate there are more temperature choices not shown on screen. If necessary, use the scroll arrows, then select the temperature required to start preheating the oven.

4. During preheating the display shows the progress as the oven heats up to the set temperature (to stop the oven heating touch the red 'X' symbol).

5. The oven is ready to use when the 'COOKBOOK' is displayed.

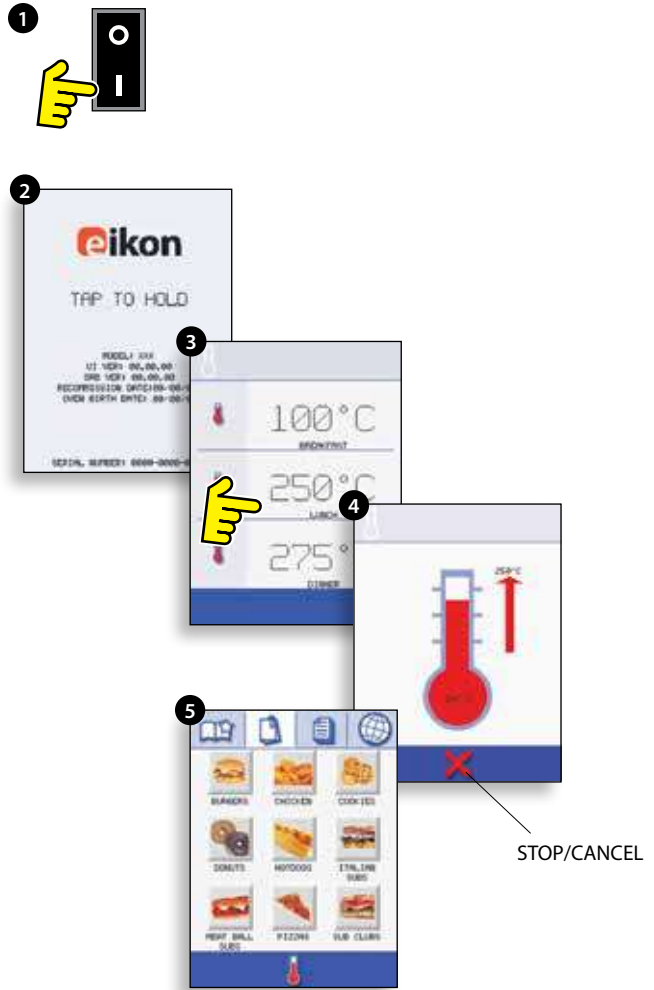

## COOKBOOK DISPLAY

MULTIPLE LANGUAGES INSTALLED  
 DISPLAYS ALL COOKING PROGRAMS (Optional)  
 SHOWS PROGRAM GROUPS  
 FAVOURITES (Optional)

PROGRAM GROUP  
 Each group contains a collection of cooking programs.



CHANGE OVEN TEMPERATURE (Optional)

## USING A COOKING PROGRAM



### CAUTION

Taking all the necessary precautions to ensure you do not burn yourself, open the oven door to place the food into the hot oven and close the door.

1. Select a program group, for example 'BURGERS', to display the individual cooking programs.
2. Select a cook program to start, for example '2 BURGERS'.
3. Follow instructions if displayed on the screen.
4. Touch the green tick to cook.

The cooking time counts down for each program stage.

5. When the program ends a red bar is displayed usually with an audible sound -- open the door or touch the red 'X' to return to the cook program.

*NOTE: Opening the oven door during cooking stops the cooking program and displays a warning. Closing the door allows the user to continue or cancel the cooking program.*

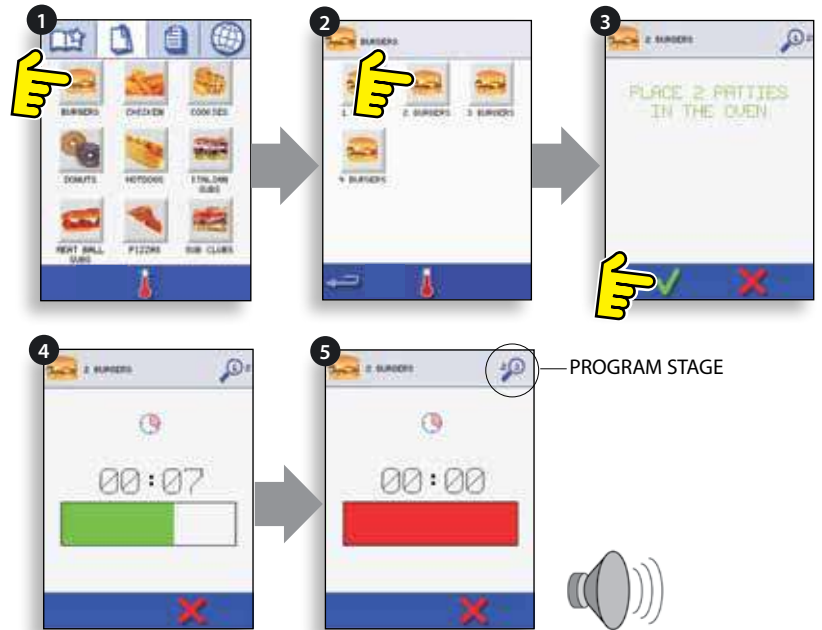

### AIR FILTER

#### IMPORTANT:

Clean the AIR FILTER (6) in the base of the oven every day and ensure that the air filter is in place prior to operating the oven.

See '*CLEANING & MAINTENANCE*'.



### SCREEN SAVER

An active screen saver will mask the screen showing a moving image. To use the touchscreen, tap the screen to deactivate the screen saver.



# OPERATING GUIDE: FULL SERVICE OVEN

## easyToUCH® MAIN MENU & KEYBOARD SCREEN

### MAIN MENU SCREEN:

1. DEVELOPMENT MODE enables multistage cooking programs to be developed, then stored under a name and symbol for reuse.
2. Press&GO® allows quick access to use the cooking programs that are already stored.
3. COOKBOOK contains the oven's cooking programs. It displays Favourites, Cooking Program Groups and a complete listing of all cooking programs available.
4. CLEANING/TEMP CHANGE allows the oven temperature to be changed and the oven to be prepared for cleaning with reminders displayed to assist during the cleaning process.
5. SETTINGS are used to control the oven settings and functions including time and language, loading cooking programs and for service and maintenance purposes.
6. KEYBOARD SCREEN is used to enter an authorised password to enter data for programs and may restrict operator access to some functions.

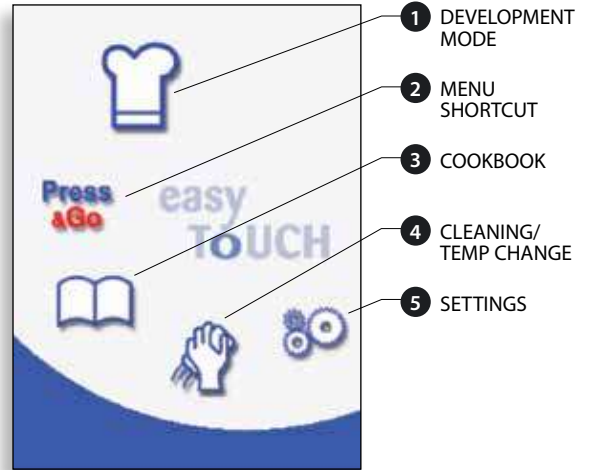

**i** For Program Names, Program Group Names and Passwords use 1-20 characters in 2 lines max.  
For Stage instructions use 1-54 characters in 5 lines max.

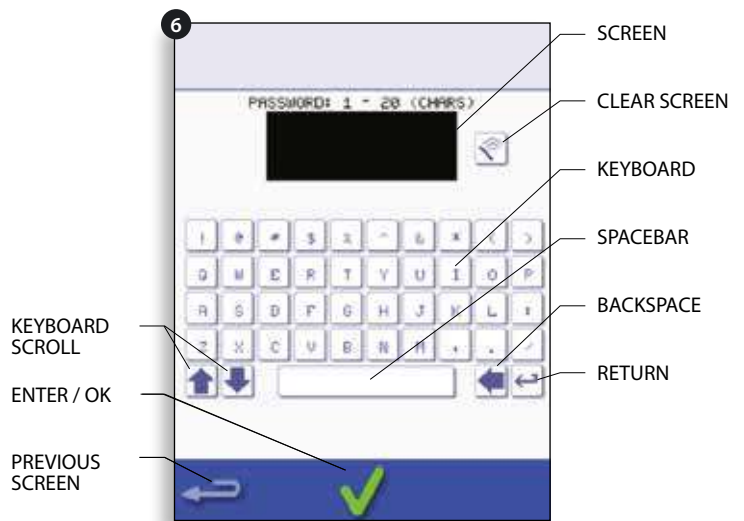

## DEVELOPMENT MODE: CREATING A COOKING PROGRAM

1. Select the 'chef's hat' symbol from the Main Menu to enter Development Mode.

### Enter Stage 1 of the Cooking Program

2. The temperature displays the set preheated oven temperature.

To increase or decrease the temperature required, select the temperature symbol (2), enter the temperature in the keypad within the limits displayed and select OK.

3. Select and set the cooking time up to a maximum of 10 minutes for each stage.

For example: Enter 110 (1 minute and 10 seconds).

4. Select and set the Microwave Power [0,5-100%]

5. Select and set a fan speed (if available) within the limits shown on screen.

6. Select the information icon to enter an instruction (optional). The instruction appears in the display at the beginning of that stage.

For example: 'Stage 1 place product in the oven'

### Enter further stages of the Cooking Program (optional)

7. Programs can have up to a maximum of 6 stages. Repeat the steps 2-6 from stage 1 above.

### Running and saving the Cooking Program

1. Select OK to confirm the Cooking Program.
2. Run the Cooking Program (optional).



**WARNING**  
ENSURE PRODUCT IS IN THE OVEN  
AND ALL SAFETY PRECAUTIONS  
ARE FOLLOWED BEFORE RUNNING  
THE PROGRAM.

If the results are not satisfactory, select the backspace, change the cooking settings and retest.

3. Select the save cookbook symbol to record the Cooking Program to the cookbook.

4. Select the camera icon to open pictures.

5. Select a picture to represent the Cooking Program (use the scroll arrows for more pictures).

6. Enter the name for the Cooking Program, using a maximum of 20 characters, for example, '1 BURGER', then select OK to save the program to the cookbook.

*NOTE: A green tick on a book icon indicates the Cooking Program has been saved to the cookbook.*



Example below: Setting the cooking time (step 3):

To set the cooking time select the Time symbol.

Enter the cooking time on the pad.

Select OK to accept the time.

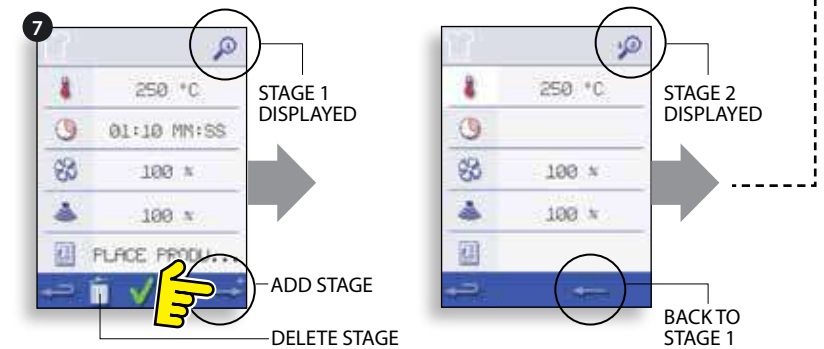
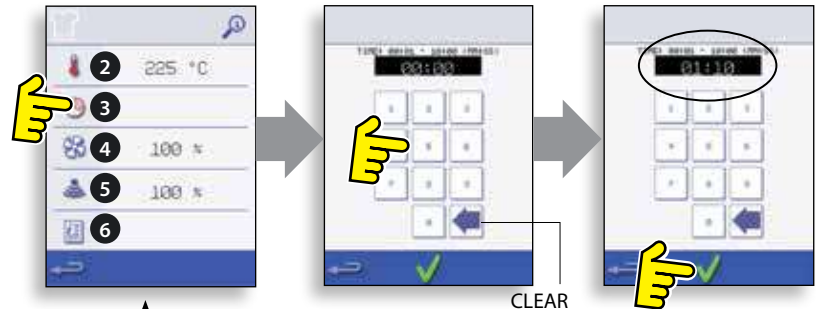



## Press&GO®

### Running a Cooking Program from the Press&GO® Menu

1. Select 'Press&GO' from the Main Menu Screen.
2. Select the item required to cook.
3. The display shows the cooking time count down. The timer bar turns red to indicate the cooking cycle has finished.



### Choosing which Cooking Programs are shown in the 'Press&GO' Menu Screen

1. After selecting 'Press&GO' from the Main Menu Screen, select the 'EDIT' symbol.
2. Two lists are displayed, the 'Press&GO' menu items are shown in the upper list and the lower list shows other menu items which are available. Both lists can be scrolled up or down using the arrows on the extreme right.
3. Select an item, then choose whether to change its order within the menu or to remove it into the lower list.
4. Select an item to move into the upper list, making it available in the 'Press&GO' menu.
5. Select backspace to return to the Menu Screen when finished.

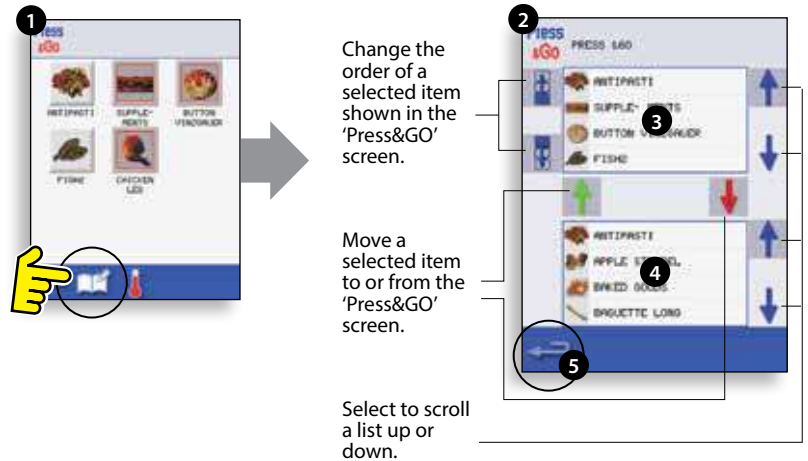

Change the order of a selected item shown in the 'Press&GO' screen.

Move a selected item to or from the 'Press&GO' screen.

Select to scroll a list up or down.

## USING A COOKBOOK PROGRAM

To find the required program in the cookbook.

**NOTICE**  
ENSURE THERE IS FOOD PRODUCT IN THE OVEN BEFORE STARTING A COOKING PROGRAM.

1. Select 'COOKBOOK' from the Main Menu Screen.
2. Select the ALL MENUS symbol.
3. Use scroll up/down arrows to find the program.

*NOTE: If an image has a red line around it the oven temperature is set too high or too low for that recipe. See 'CHANGING THE OVEN TEMPERATURE'.*

Taking all the necessary precautions to ensure you do not burn yourself, place the food product into the hot oven cavity and close the door.



**WARNING**  
HOT SURFACE HAZARD

4. Select the required Cooking Program to start cooking. For example, '1 BURGER'.
5. The program either starts immediately displaying a countdown timer, or an instruction is displayed first. Follow the stage instruction and then select OK to start cooking. If the oven door is not opened within 30 seconds a warning message appears.
6. The cooking timer counts down to zero and makes a sound to indicate an operator action is required at the end of a cooking stage or the end of a Cooking Program.



Once the Cooking Program has finished, opening the oven door to remove the food returns the display to the 'COOKBOOK' screen.

*NOTE: Opening the oven door during cooking stops the Cooking Program and displays a warning. Closing the door allows the user to continue or cancel the Cooking Program.*

*To check the oven temperature when cooking, lightly tap the temperature displayed. The oven cavity temperature is shown with an asterisk.*

### CHANGING THE OVEN TEMPERATURE

1. Take note of the temperature required for the recipe and select OK.
2. Select the temperature symbol.
3. An asterisk next to the number indicates the present oven temperature, select the required oven temperature for the recipe. Once the oven is at the required temperature continue from selecting the 'COOKBOOK' in step 1.



### VIEWING & EDITING COOKING PROGRAMS

1. Select 'COOKBOOK' from the Main Menu Screen.
2. Select the ALL MENUS symbol.
3. Select 'EDIT COOKBOOK'.
4. Use the up/down scroll arrows on the right side of the screen to find the Cooking Program, for example '1 BURGER' and select the view/edit Cooking Program symbol.
5. View or adjust the program as required, see 'DEVELOPMENT MODE' for details.



## ADDING A NEW PROGRAM GROUP

1. Select 'COOKBOOK' from the Main Menu Screen.
2. Select 'EDIT COOKBOOK'.
3. Select the 'ADD A NEW GROUP' symbol.
4. Select the camera icon to open pictures.
5. Select a picture to represent the Program Group (use the scroll arrows for more pictures).
6. Enter a name for the new Program Group (max. 20 characters) and select OK to save the Program Group to the cookbook.

Select backspace to return to the 'COOKBOOK'.

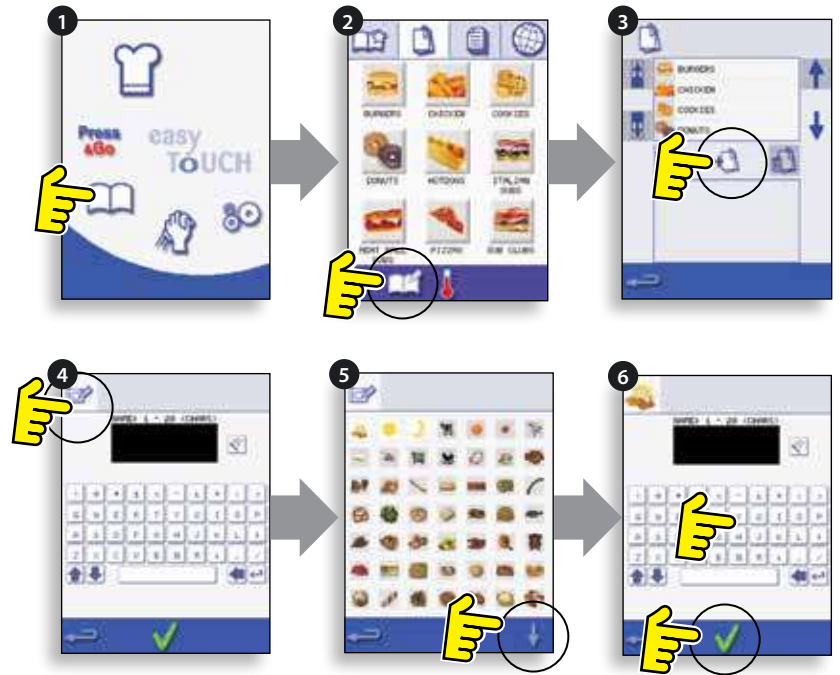

## MOVE A COOKING PROGRAM WITHIN A PROGRAM GROUP

Example: Moving the position of the '4 BURGERS' Cooking Program within the Cooking Program Group called 'BURGERS'.

1. Select 'COOKBOOK' from the Main Menu Screen.
2. Select the 'BURGERS' Program Group.
3. Select 'EDIT COOKBOOK'.
4. Use the up/down scroll arrows on the right side of the upper part of the edit screen to view the Cooking Programs in the Program Group.

Then select the Cooking Program to be moved ('4 BURGERS') and use the up/down arrows on the left side of the upper screen to move the selected program within the Program Group.

Select backspace to return to the 'COOKBOOK' screen.

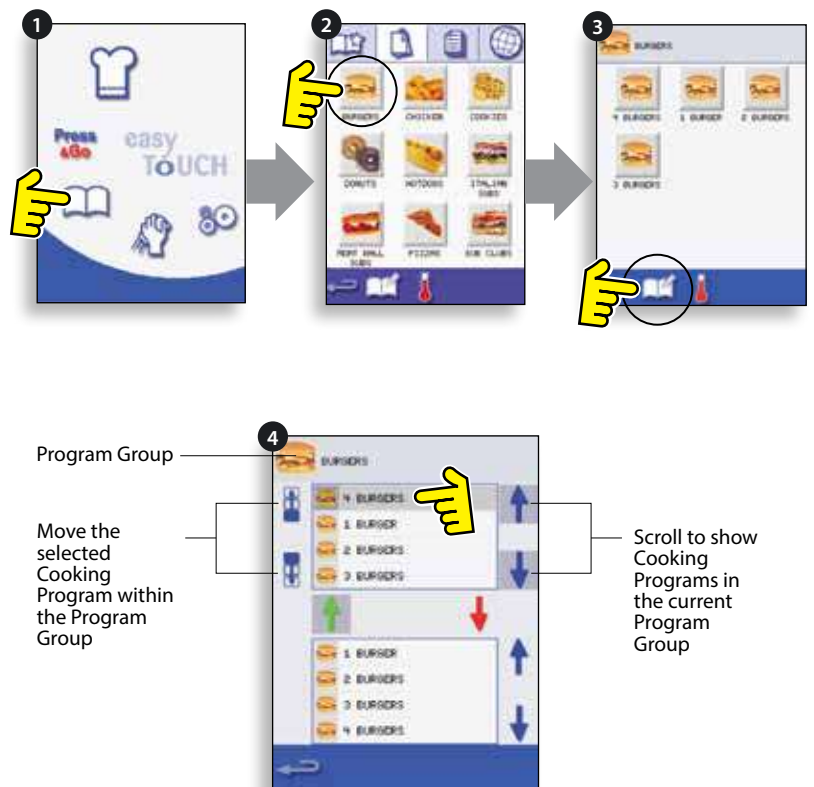

## ADDING A COOKING PROGRAM TO A PROGRAM GROUP

Example: Add program '4 BURGERS' to the Program Group 'BURGERS'.

1. Select 'COOKBOOK' from the Main Menu Screen.
2. Select the 'BURGERS' Program Group.
3. Select 'EDIT COOKBOOK'.
4. In the lower part of the screen use the up/down scroll arrows on the right side to find and select the '4 BURGERS' Cooking Program.
5. Select the green UP arrow to add the '4 BURGERS' Cooking Program to the Program Group in the upper part of the screen, then select backspace to return to the Cooking Programs.
6. Select backspace again to return to the 'COOKBOOK'.

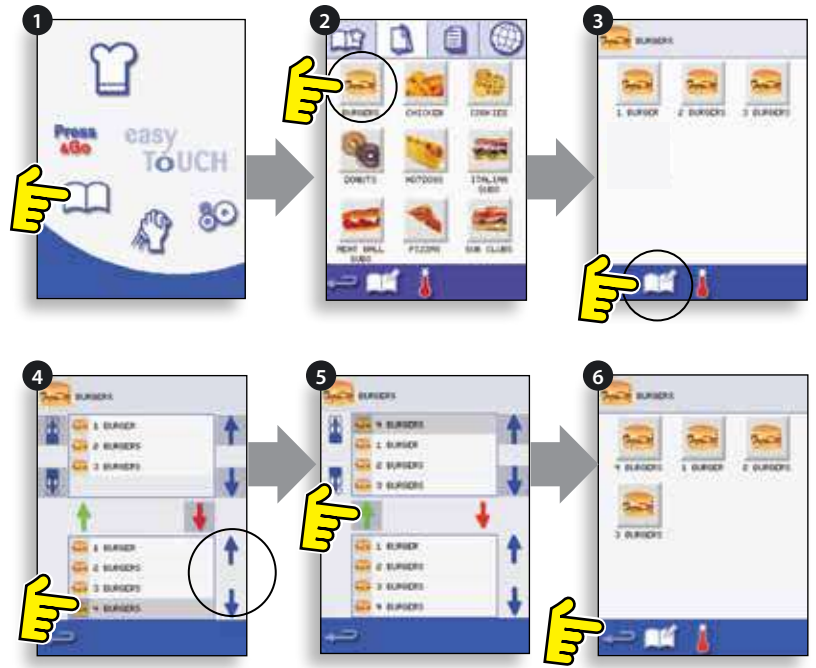

## MANAGING PROGRAM GROUPS

### To move a Program Group Position in a Program Group List

1. Select 'COOKBOOK' from the Main Menu Screen.
2. Select 'EDIT COOKBOOK'.
3. Use the scroll arrows, up and down on the right side of the screen to locate all the Program Groups.
4. Select the Program Group to be moved and use the up and down arrows on the left side of the screen to move the selected Program Group.
5. Select backspace to go back to the 'COOKBOOK'.



### To change the Program Group Name

- Select the Program Group.
- Select 'EDIT PROGRAM GROUP'.
- Enter the new name and select OK.

### To delete a Program Group

- Select the Program Group.
- Select the DELETE Program Group symbol.
- Select OK to delete the Program Group.

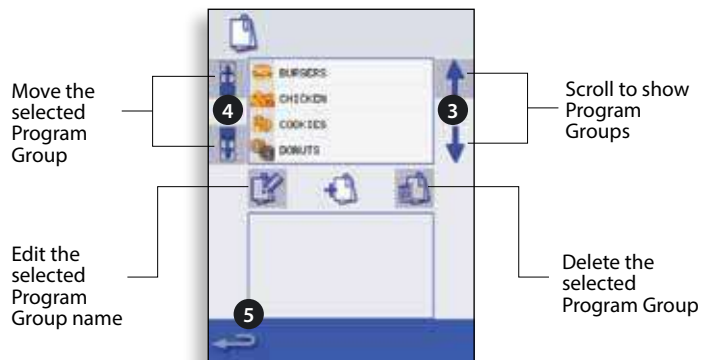

# OVEN CONTROL SETTINGS

1. Select the 'settings' symbol from the main menu screen.

2. Enter the password and select OK to display the Settings menu (3) comprising:

- A. Oven mode/navigation settings.
- B. Language options.
- C. Oven temperature settings and labels.
- D. Service information and error logs (password required).
- E. Recipe counters.
- F. Date & time settings.
- G. Speaker sound levels.
- H. Oven Timer (Temperature/ON/OFF).
- J. USB program connection.
- K. Temperature Band.
- L. Change Settings/Service access passwords.
- M. Screen saver.

When finished with a setting, select backspace to return to the main settings menu.

To exit the settings menu, select backspace, a prompt will be displayed to either 'SAVE' or 'DISCARD' any changed settings (4).

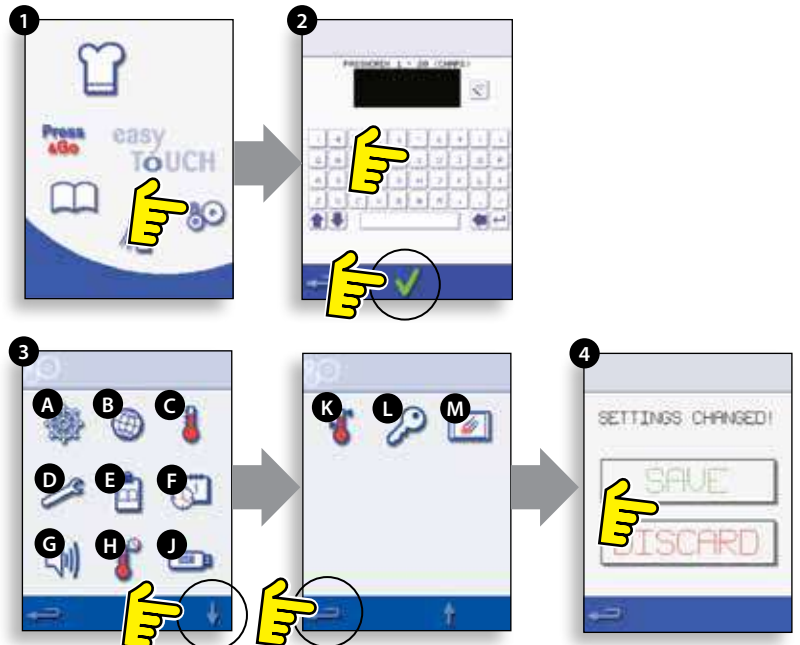

## Oven Mode/Navigation Settings (A)

Select the Oven Mode/Navigation Symbol (A) from the 'Settings' menu.

Select 'Quick Serve Mode' for cooking only, or 'Full Serve Mode' for cooking & development programs or 'Manual Mode' to manually cook only via the 'Chef's hat' symbol.

Select 'Enable Settings' to display an 'unlock' symbol on the Quick Serve Cookbook screen to allow access to the 'Settings' menu.

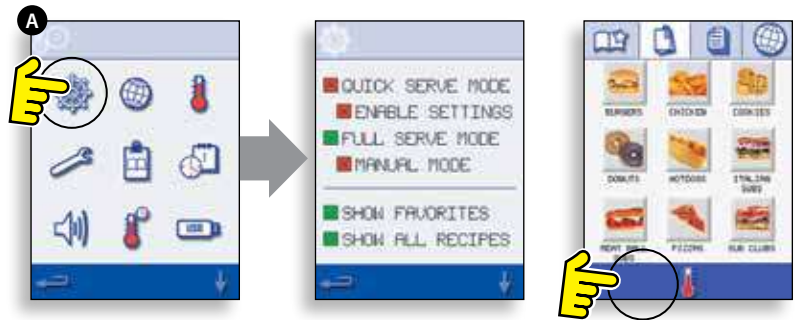

## Language Options (B)

Select the globe symbol (B).

Select the checkbox of the required language from the list shown.

## Oven Temperature Settings and Labels (C)

To change the oven preheat temperature, select the temperature symbol (C) to display the keypad, enter the required temperature and select OK.

Note, the temperature options screen is only displayed at start up when two or more temperatures are set above minimum.

To change a temperature label, select the label to display the keyboard, enter the required label name and select OK.

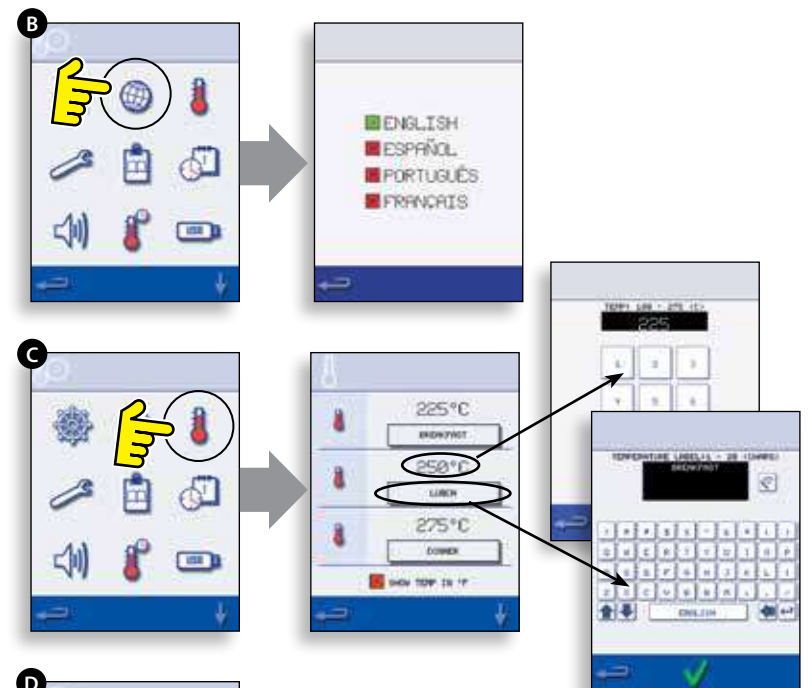

## For Service Information & Error Logs (D) refer to Servicing.



### Recipe Counters (E)

Select the clipboard symbol to display a listing of recipe counters.

If shown, use the arrows (bottom right) to scroll up and down the list.

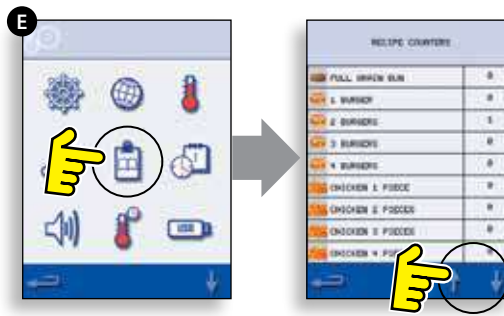

### Date and Time Settings (F)

Select the time/date symbol to display the setting options.

**CHANGE THE DATE:** Select 'MONTH', enter the correct Month on the keypad and select OK.

Select 'DAY', enter the correct Day on the keypad and select OK.

Select 'YEAR', enter the correct last two digits of the Year on the keypad and select OK.

To display the Month first, followed by the Day and Year, select the 'MM-DD-YY' checkbox.

*NOTE: The Error Logs are recorded using these settings.*

**CHANGE THE TIME:** Select 'HOUR', enter the correct Hour on the keypad and select OK.

Select 'MIN', enter the correct Minutes on the keypad and select OK.

Select the day name shown to cycle through to display the correct weekday.

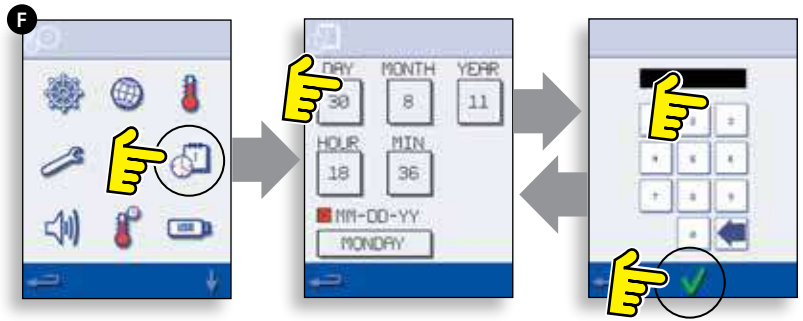

### Sound Levels (G)

Select the speaker symbol to adjust the volume level suitable for the environment from none (OFF) to the loudest (100%).

Select music note symbol to set LOW, MED (medium) or HIGH tone.

Select the keypad symbol to switch the sound ON or OFF when the touchscreen is pressed.



### Oven Timer (H)

Select the thermometer/timer symbol.

Select the 'Timer Enabled' checkbox (green tick).

Select a weekday using the up/down arrows.

Select an empty 'Time' box (maximum of 5 per day) or clear the box using the wipe symbol.

Enter the start time on the keypad and select OK.

Select an empty 'Temperature' box opposite the Time box displaying the time just entered, or clear the box using the wipe symbol next to it.

Enter the cavity temperature required on the keypad and select OK.

*NOTE: You can also select zero to turn the heat off. Selecting the red circle symbol will switch the oven OFF.*

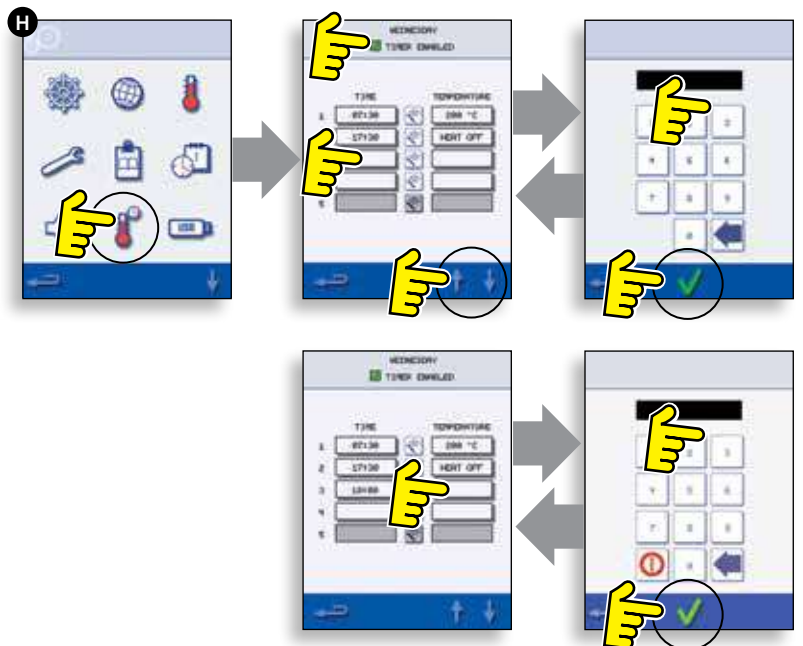

## USB Oven Programs (J)

**IMPORTANT:** Downloading from a USB will clear all the existing programs.

Check that the key has the correct number/code for the programs you want to load into the oven memory (1 '.cbr' + 'autoupd.ate').

With the oven switched off, slide the Merrychef badge (oven front top right) upwards and insert the USB Memory Stick into the slot.

Switch the oven ON.

The files automatically download from the USB showing the progress and confirmation screens for the update.

On completion the oven displays the start up screen.

Remove the USB and keep in a safe place.  
Reposition the USB cover.

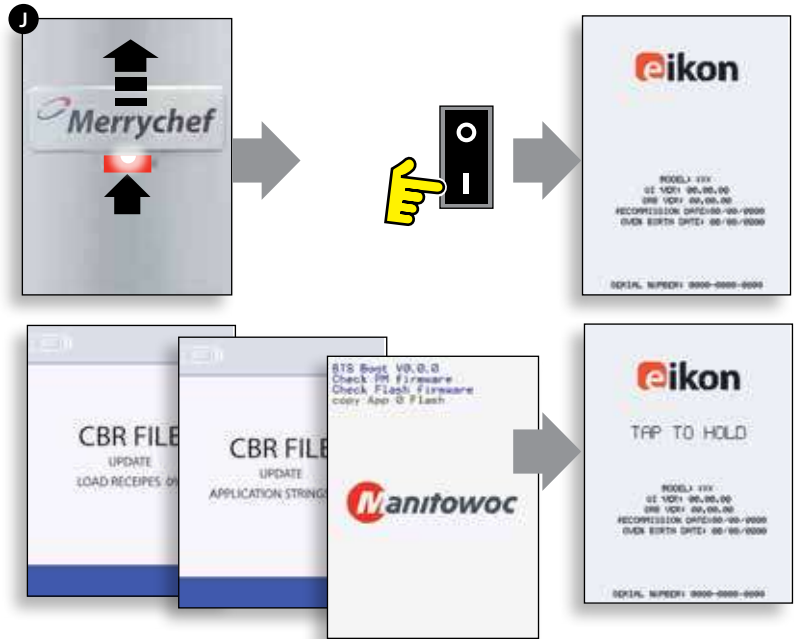

## Temperature Band (K)

Select the 'Temp Band' symbol at which the oven controls i.e.  $\pm 10^{\circ}\text{C}$ .

Select the required temperature band checkbox, shown by a green tick.

*NOTE: Although the lowest practical Temp Band should be used, if the set oven temperature falls by more than the selected Temp Band, the ready to cook mode and Temp Band are deactivated until the oven reaches the preheat temperature.*

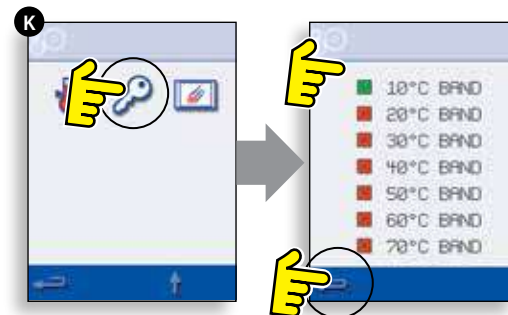

## Change Password (L)

Select the key symbol to change the oven passwords.

Select the oven settings or service symbol.

Enter the existing password and select OK to confirm.

Enter the new password, select OK.

Confirm new password, select OK.

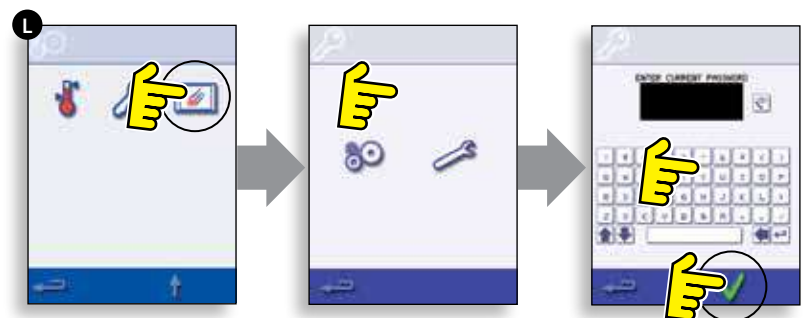

## Screen Saver (M)

Select the ENABLED checkbox to switch the screen saver ON or OFF.

Select the time box below to enter a time delay on the keypad from 1 to 60 minutes before the screen saver starts and select OK to confirm.

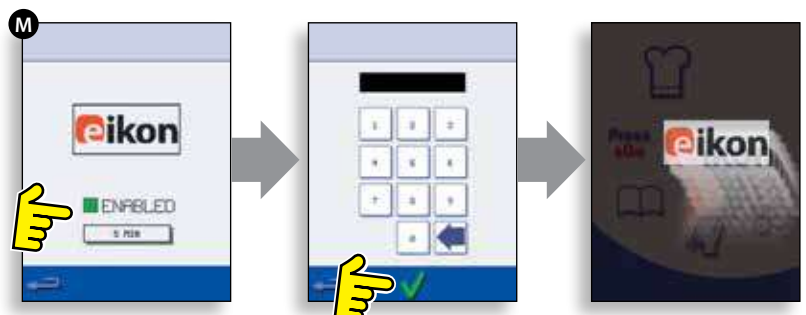

# COOLING THE OVEN DOWN BEFORE CLEANING

## Oven cool down

**IMPORTANT:** the oven must be cooled down before the cleaning processes are carried out.

1. In Full Serve mode, select the CLEANING symbol from the main menu.
2. In Full or Quick Serve mode, select the blue thermometer symbol to disable heating and start the cooling cycle.
3. Taking all necessary precautions place a suitable container of ice or cold water (to speed up the cooling process) into the hot oven cavity. Select the OK symbol to continue.
4. The cooling progress is displayed and takes approximately 30 minutes. Note that the oven will continue to cool should the door be opened during the cool down procedure.
5. Once the cooling process is complete, carefully remove the cool down pan. The pan and water maybe hot so an oven cloth or gloves should be used.
6. The oven is now ready for cleaning. Select OK on the screen after completing each stage.

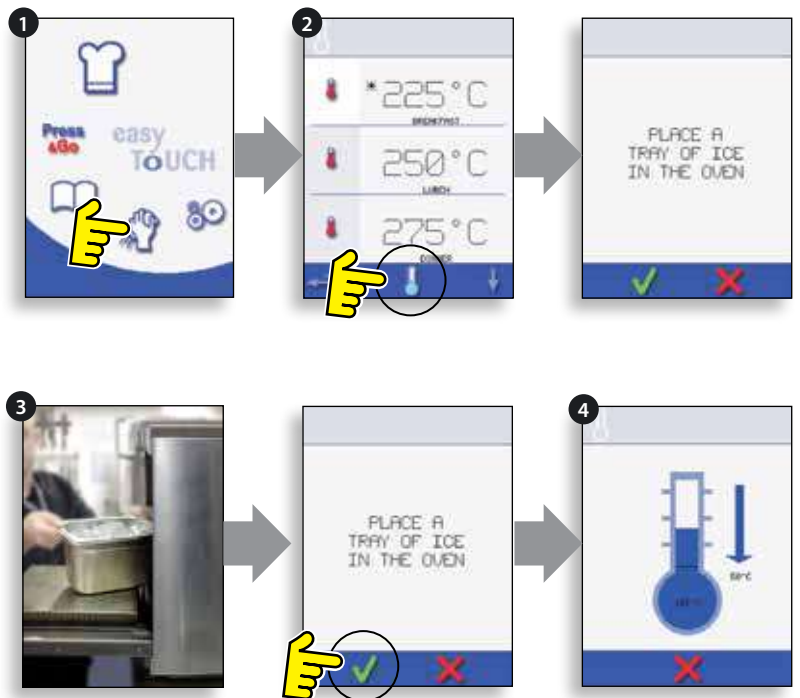

## Preparing to clean the oven

For the oven to operate at peak efficiency, the cavity, door, air filter and grease filter must be kept clean.

A daily cleaning routine will ensure that you comply with the required hygiene standards and will help to maintain and prolong the efficiency of your oven.



## Equipment required (not supplied)

- Merrychef® approved oven cleaner
- Merrychef® approved oven protector
- Heat proof gloves
- Protective rubber gloves
- Non-abrasive nylon scrub pad
- Cleaning towel and cloths
- Eye protection
- Dust mask (optional).



**CAUTION**  
WEAR PROTECTIVE RUBBER GLOVES WHEN CLEANING THE OVEN.

**NOTICE**  
DO NOT USE CAUSTIC CLEANERS ON ANY PART OF THE OVEN OR OVEN CAVITY AS IT WILL CAUSE PERMANENT DAMAGE TO THE CATALYTIC CONVERTERS.



# e3 Cold oven CLEANING INSTRUCTIONS e3

Complete COOL DOWN procedure and allow the oven and accessories to cool before commencing cleaning.

**NOTICE**  
**DO NOT USE TOOLS.**  
**NEVER USE SHARP IMPLEMENTS OR HARSH ABRASIVES ON ANY PART OF THE OVEN.**

## REMOVE & CLEAN OVEN PARTS

1. Switch off the oven.
2. Remove the air filter at the base of the oven.
3. Open the oven door and lift out the turntable tray and turntable disc.
4. For ovens with a catalytic converter: Open the oven door and undo fasteners from cavity rear to remove the catalytic converter when required or at least once a month.
5. Wash all parts in warm soapy water. Wash off using a clean cloth and plenty of clean, warm water. Ensure all components are dry before re-fitting them.
6. Dry using a fresh, clean cloth.

## CLEAN THE OVEN

1. Remove any spillages with suitable cloth/paper towel.  
Use a dry clean brush to remove any food particles from between the oven floor and the inside of the front door.

2. Wear protective rubber gloves and protective glasses following manufacturer's recommendations. Carefully spray a Merrychef® approved oven cleaner onto all the internal surfaces of the oven except the door seal (A).

**DO NOT spray directly into the fan opening at the rear inside of the oven.**

3. For difficult areas, leave to soak for 10 minutes with the oven door open.

Use a non-abrasive nylon scrub pad/sponge to clean the cavity, roof and the inside of the door. Do not scrub the door seal or use metallic scourers.

4. Wash off using a clean cloth and plenty of clean warm water and dry using a fresh clean cloth or paper towel. Ensure all components are dry before re-fitting them.

5. Replace all the cleaned oven parts.

6. Close the oven door and wipe the outside of the oven with a damp cloth.

7. Now press the green check mark.

**NOTICE**  
**DO NOT USE THE OVEN WITHOUT A CLEAN AIR FILTER IN PLACE.**

## APPLY OVEN PROTECTOR

1. Only apply to a clean oven. Spray a Merrychef® approved oven protector onto a sponge.
2. Spread the oven protector lightly onto all internal surfaces of the oven avoiding the door seal, cooking surfaces, fan inlets and outlets.
3. Close the door and switch on the oven. If the air filter has not been replaced the touch screen will display a warning. Replace the air filter and then press the green check mark.
4. Preheat the oven. Once the oven has reached operating temperature, it will take about 30 minutes to cure the oven protector.

*NOTE: The oven protector turns light brown when cured.*

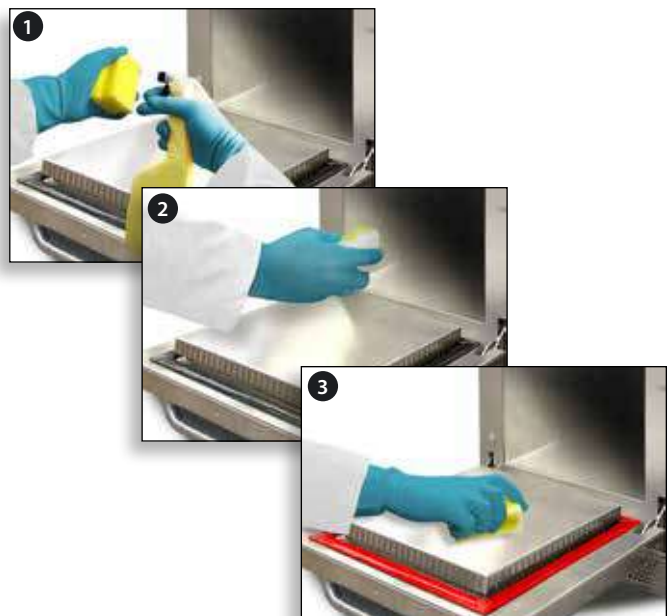
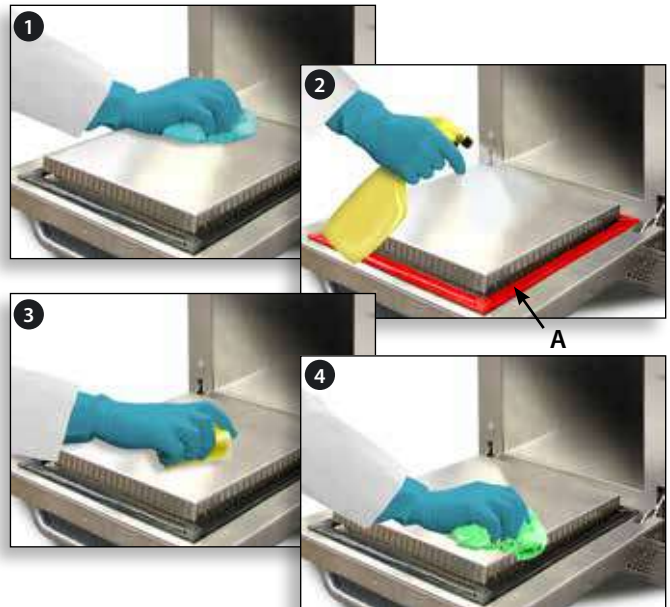
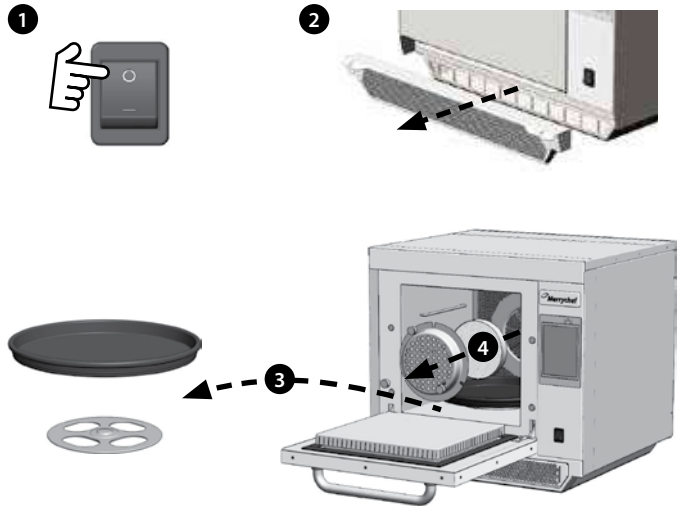

# e4 Cold oven CLEANING INSTRUCTIONS e4

Complete COOL DOWN procedure and allow the oven and accessories to cool before commencing cleaning.

**NOTICE**  
DO NOT USE TOOLS.  
NEVER USE SHARP IMPLEMENTS OR HARSH  
ABRASIVES ON ANY PART OF THE OVEN.

## REMOVE & CLEAN OVEN PARTS

1. Switch off the oven.
2. Remove the air filter at the base of the oven.
3. Open the oven door and lift out the grease filter assembly at the rear of the cavity.
4. Remove the upper impinger plate by undoing the 2 thumb nuts located at the top of the cavity.
5. Remove the lower impinger plate and the wire rack from the cavity.
6. Wash all parts in warm soapy water. Wash off using a clean cloth and plenty of clean, warm water. Ensure all components are dry before re-fitting them.
7. Dry using a fresh, clean cloth.

## CLEAN THE OVEN

1. Remove any spillages with suitable cloth/paper towel.  
Use a dry brush to remove any food particles from between the oven floor and the inside of the front door.

2. Wear protective rubber gloves and protective glasses following manufacturer's recommendations. Carefully spray a Merrychef® approved oven cleaner onto all the internal surfaces of the oven except the door seal (A).

**DO NOT spray directly into the fan opening at the rear inside of the oven.**

3. For difficult areas, leave to soak for 10 minutes with the oven door open.

Use a non-abrasive nylon scrub pad/sponge to clean the cavity, roof and the inside of the door. Do not scrub the door seal or use metallic scourers.

4. Wash off using a clean cloth and plenty of clean warm water and dry using a fresh clean cloth or paper towel. Ensure all components are dry before re-fitting them.

5. Replace all the cleaned oven parts.

6. Close the oven door and wipe the outside of the oven with a damp cloth.

7. Now press the green check mark.

**NOTICE**  
DO NOT USE THE OVEN WITHOUT A CLEAN  
AIR FILTER IN PLACE.

## APPLY OVEN PROTECTOR

1. Only apply to a clean oven. Spray a Merrychef® approved oven protector onto a sponge.
2. Spread the oven protector lightly onto all internal surfaces of the oven avoiding the door seal, cooking surfaces, fan inlets and outlets.
3. Close the door and switch on the oven. If the air filter has not been replaced the touch screen will display a warning. Replace the air filter and then press the green check mark.
4. Preheat the oven. Once the oven has reached operating temperature, it will take about 30 minutes to cure the oven protector.

*NOTE: The oven protector turns light brown when cured.*

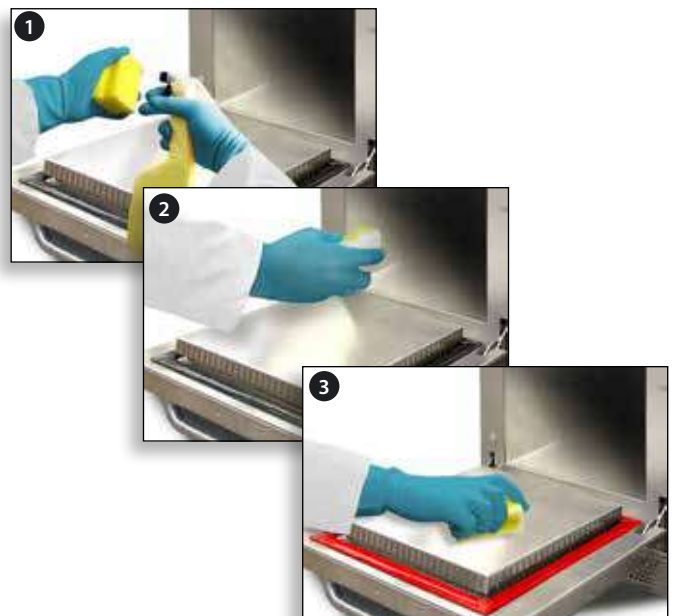
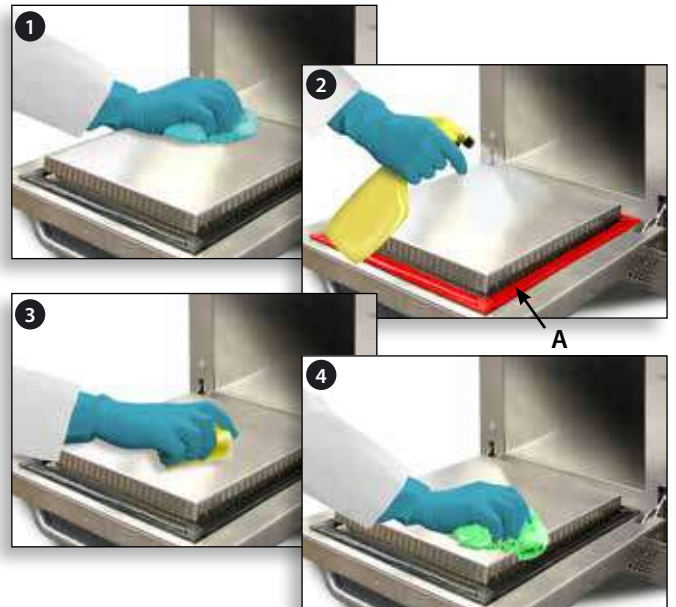
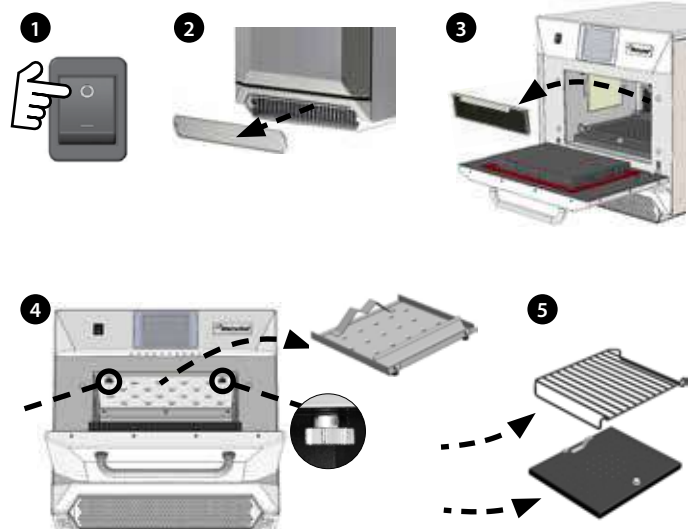

# e5 Cold oven CLEANING INSTRUCTIONS e5

Complete COOL DOWN procedure and allow the oven and accessories to cool before commencing cleaning.

**NOTICE**  
**DO NOT USE TOOLS.**  
**NEVER USE SHARP IMPLEMENTS OR HARSH ABRASIVES ON ANY PART OF THE OVEN.**

## REMOVE & CLEAN OVEN PARTS

1. Switch off the oven.
2. Remove the air filter at the base of the oven.
3. Open the oven door and remove any cooking trays/rack.
4. Wash all parts in warm soapy water. Wash off using a clean cloth and plenty of clean, warm water. Ensure all components are dry before re-fitting them.
5. Dry using a fresh, clean cloth.

## CLEAN THE OVEN

1. Remove any spillages with suitable cloth/paper towel. Use a dry clean brush to remove any food particles from between the oven floor and the inside of the front door.
2. Wear protective rubber gloves and protective glasses following manufacturer's recommendations. Carefully spray a Merrychef® approved oven cleaner onto all the internal surfaces of the oven except the door seal (A).

**DO NOT spray directly into the fan opening at the rear inside of the oven.**

3. For difficult areas, leave to soak for 10 minutes with the oven door open.

Use a non-abrasive nylon scrub pad/sponge to clean the cavity, roof and the inside of the door. Do not scrub the door seal or use metallic scourers.

4. Wash off using a clean cloth and plenty of clean warm water and dry using a fresh clean cloth or paper towel. Ensure all components are dry before re-fitting them.
5. Replace all the cleaned oven parts.
6. Close the oven door and wipe the outside of the oven with a damp cloth.
7. Now press the green check mark.

**NOTICE**  
**DO NOT USE THE OVEN WITHOUT A CLEAN AIR FILTER IN PLACE.**

## APPLY OVEN PROTECTOR

1. Only apply to a clean oven. Spray a Merrychef® approved oven protector onto a sponge.
2. Spread the oven protector lightly onto all internal surfaces of the oven avoiding the door seal, cooking surfaces, fan inlets and outlets.
3. Close the door and switch on the oven. If the air filter has not been replaced the touch screen will display a warning. Replace the air filter and then press the green check mark.
4. Preheat the oven. Once the oven has reached operating temperature, it will take about 30 minutes to cure the oven protector.

*NOTE: The oven protector turns light brown when cured.*

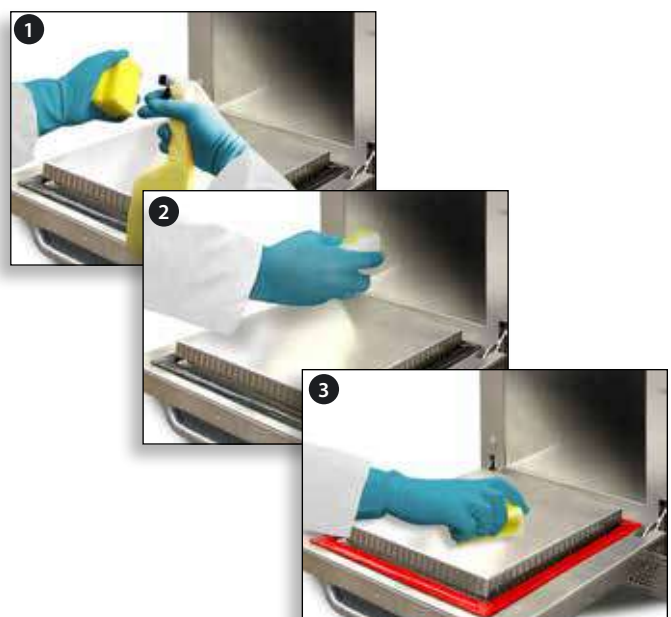
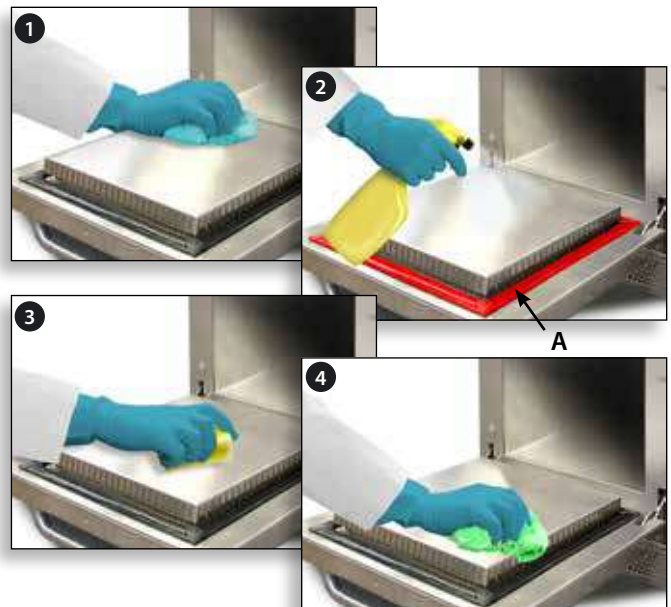
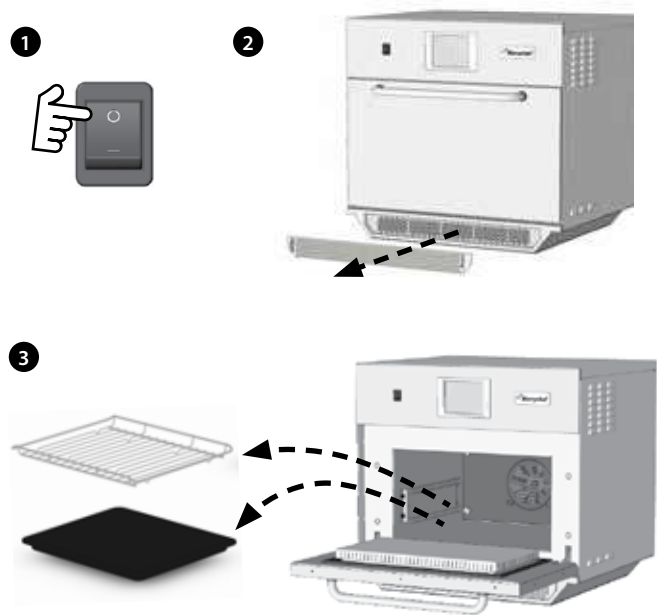

# FAULT FINDING CHART

Although every effort is made to ensure your oven will continue to perform to a high standard, please check the chart to see if the problem can be easily resolved before contacting your service agent.

PROBLEM	POSSIBLE CAUSE	REMEDY
The oven does not work and the display screen is blank	The oven has no power	Check if there is a power cut. Check the isolator switch is ON or the oven is plugged in correctly. Check the oven switch is ON.
Some screen controls do not work	Unauthorised access	Contact the authorised user.
Display shows a warning message	Details are shown on screen	Follow the instructions displayed.
The oven does not cook the food correctly	Oven not clean Food not at correct temperature Modified or wrong program selected Food wrapped Food removed early	Clean the oven (see 'CLEANING'). Use the correct cooking program. Unwrap food for non-microwave cooking. Check all the cooking stages have been followed correctly.
The oven does not finish cooking	Warning message displayed Oven door opened No air filter or incorrectly fitted Oven overheating	Close oven door. Refit air filter. Allow the oven to cool down. Check and remove any restrictions around the air vents.
Display shows an error code	Oven malfunction	Note the error code and contact your service agent.

# SERVICING



Merrychef approved Service Agent:

## Correct disposal of this product (Waste Electrical & Electronic Equipment)



Applicable in the European Union and other European countries with separate collection systems.

This marking shown on the product or its literature indicates that it should not be disposed with other household wastes at the end of its working life. To prevent possible harm to the environment or human health from uncontrolled waste disposal, please separate this from other types of wastes and recycle it responsibly to promote the sustainable reuse of material resources.

Household users should contact either the retailer where they purchased this product, or their local government office for details of where and how they can take this item for environmentally safe recycling.

Business users should contact their supplier and check the terms and conditions of the purchase contract. This product should not be mixed with other commercial wastes for disposal.

© 2019 Welbilt UK Ltd. All rights reserved.

Continuing product improvement may necessitate change of specifications without notice.

