

This document covers ARX* and MRX* series models

Owner's Manual

HIGH SPEED COMMERCIAL COMBINATION OVEN

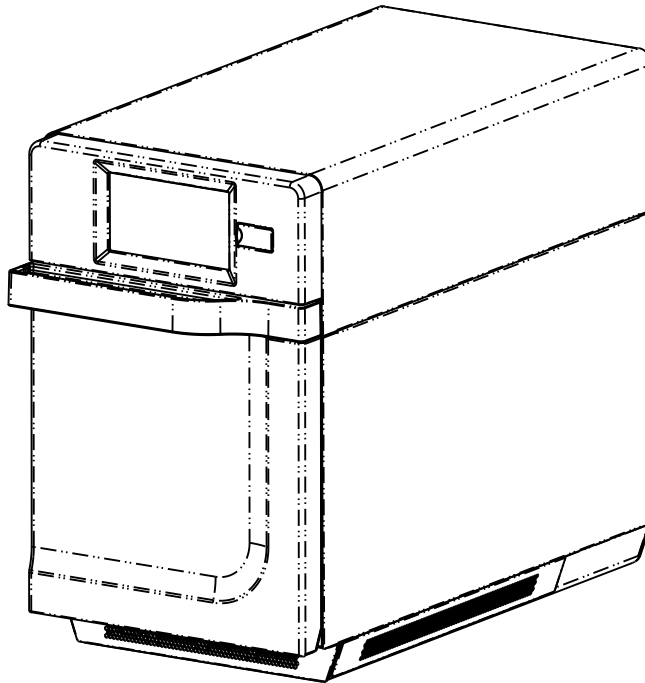

Keep these instructions for future reference. If the equipment changes ownership, be sure this manual accompanies equipment. Please refer to the SAFETY INSTRUCTIONS for important safety information prior to using this oven



Table of Contents

Model Identification	3
Online Oven Resources	3
<i>ACP Programming Application:</i>	3
<i>Firmware Updates</i>	3
Important Safety Instructions	4-5
Grounding and Installation	6
Cooking Tips	7
Features	8
Touch Panel Menu Descriptions	9
Touch Screen Icon Descriptions	10
General Oven Operation	11
Preprogrammed Menu	12
Cooking with Preprogrammed Menu Items.....	12
Preprogrammed Menu Items	13
Manual Cooking	14
Manual Programming	15
Save a Menu Item from Manual Cook:	15
Manually Edit an Existing Menu Item:.....	15
Manually Move Recipe:.....	15
Manual Organization: Folders	16
Manual Organization: Tabs	17
Oven Programming: USB Flash Drive	18
Export Menu via USB Flash Drive	18
Open Menu in ACP Programming Application	18
Import Menu via USB Flash Drive.....	18
Oven Programming: Wi-Fi and Ethernet	19
Connect Oven to Network:.....	19
<i>To connect via Wi-Fi:</i>	19
<i>To connect via Ethernet:</i>	19
Connect Computer to Oven via Wi-Fi/Ethernet:.....	19
Transfer Recipe Information via Wi-Fi/Ethernet:.....	19
<i>Log-in Information</i>	19
Care and Cleaning	20-21
Recommended Cleaning Supplies	20
For a new oven, before using it for the first time.....	20
Best Practices	20
Daily Cleaning.....	21
Weekly Cleaning	21
1. <i>Clean Air Filter</i>	21
User Options	22
Access and Modify User Options:	22
Default User Options	23
Before Calling for Service	24

Model Identification

When contacting ACP, provide product information. Product information is located on oven serial plate. Record the following information:

Model Number: _____
Serial or S/N Number: _____
Date of installation: _____
Dealer's name and address: _____

Any questions or to locate an authorized ACP servicer, call ACP ComServ Service Support.

- **Inside** the U.S.A. or Canada, call toll-free at 866-426-2621.
- **Outside** the U.S.A. and Canada, call 319-368-8195.
- **Email:** commercialservice@acpsolutions.com

Warranty service must be performed by an authorized ACP servicer. ACP also recommends contacting an authorized ACP servicer, or ACP ComServ Service Support if service is required after warranty expires.

Before using your oven, please take the time to read the Safety Instructions which shipped with the oven.

Information herein is subject to change without notice. Errors are subject to correction. For the most recent product literature, please visit acpsolutions.com/product-literature/

Online Oven Resources

ACP Programming Application



Download and install the ACP Programming Application to create, edit, and customize menu and display settings for your oven, using a desktop computer or tablet. To download the latest and greatest version of the ACP Programming Application please visit acpsolutions.com/oven-programming/

Firmware Updates



For the optimal user experience, ACP recommends using the latest version of oven firmware. To download firmware updates and installation instructions, or to opt-in for email update notifications, please visit acpsolutions.com/oven-programming/

IMPORTANT SAFETY INSTRUCTIONS

 **RECOGNIZE THIS SYMBOL AS A SAFETY MESSAGE**

WARNING

When using electrical equipment, basic safety precautions should be followed to reduce the risk of burns, electrical shock, fire, or injury to persons including the following.

1. READ all instructions before using equipment.
2. READ AND FOLLOW the specific "PRECAUTIONS TO AVOID POSSIBLE EXPOSURE TO EXCESSIVE MICROWAVE ENERGY" on this page.
3. This equipment **MUST BE GROUNDED**. Connect only to properly GROUNDED outlet. See "GROUNDING / EARTHING INSTRUCTIONS" on page 6.
4. Install or locate this equipment **ONLY** in accordance with the installation instructions in this manual.
5. Liquids or other foods, must **NOT** be HEATED in sealed containers since they are liable to explode.
6. Eggs in their shell and whole hard-boiled eggs should **NOT** be HEATED in microwave ovens since they may explode even after microwave heating has ended.
7. Use this equipment **ONLY** for its intended use as described in this manual. Do not use corrosive chemicals or vapors in this equipment. This type of oven is specifically designed to heat, cook, or dry food. It is not designed for industrial or laboratory use.
8. This appliance is **NOT** intended for use by persons (including children) with reduced physical, sensory or mental capabilities, or lack of experience and knowledge, unless they have been given supervision or instruction concerning use of the appliance by a person responsible for their safety
9. **CHILDREN SHOULD BE SUPERVISED** to ensure that they **DO NOT** play with the appliance
10. Failure to maintain the oven in a clean condition could lead to deterioration of the surface that could adversely affect the life of the appliance and possibly result in a hazardous situation;
11. See door cleaning instructions on page 20-21 of this product safety manual.
12. **DO NOT** heat baby bottles in oven. Baby food jars shall be open when heated and contents stirred or shaken before consumption, in order to avoid burns.
13. **DO NOT** operate this equipment if it has a damaged cord or plug, if it is not working properly, or if it has been damaged or dropped.
14. This equipment, including power cord, must be serviced **ONLY** by qualified service personnel. Special tools are required to service equipment. Contact nearest authorized service facility for examination, repair, or adjustment.
15. **DO NOT** cover or block louvers or other openings on equipment.
16. **DO NOT** store this equipment outdoors. **DO NOT** use this product near water – for example, near a kitchen sink, in a wet basement, a swimming pool, or a similar location.
17. **DO NOT** immerse cord or plug in water.
18. Keep cord **AWAY** from HEATED surfaces.
19. **DO NOT** let cord hang over edge of table or counter.
20. For commercial use only.

PRECAUTIONS TO AVOID POSSIBLE EXPOSURE TO EXCESSIVE MICROWAVE ENERGY

- A. **DO NOT** attempt to operate this oven with the door open since open door operation can result in harmful exposure to microwave energy. It is important not to defeat or tamper with the safety interlocks.
- B. **DO NOT** place any object between the oven front face and the door to allow soil or cleaner residue to accumulate on sealing surfaces.
- C. **DO NOT** operate the oven if it is damaged. It is particularly important that the oven door close properly and that there is no damage to the:
 1. door (bent)
 2. hinges and latches (broken or loosened)
 3. door seals and sealing surfaces.
- D. The oven should not be adjusted or repaired by anyone except properly qualified service personnel.

SAVE THESE INSTRUCTIONS

WARNING

To avoid risk of fire in the oven cavity:

- a. DO NOT overcook food. Carefully attend oven when paper, plastic, or other combustible materials are placed inside the oven, due to the possibility of ignition.
- b. Remove wire twist-ties from paper or plastic bags before placing bag in oven.
- c. If materials inside the oven ignite, keep oven door CLOSED, turn oven off and disconnect the power cord, or shut off power at the fuse or circuit breaker panel.
- d. DO NOT use the cavity for storage. DO NOT leave paper products, cooking utensils, or food in the cavity when not in use.

WARNING

Liquids such as water, coffee, or tea are able to be overheated beyond the boiling point without appearing to be boiling due to surface tension of the liquid. Visible bubbling or boiling when the container is removed from the microwave oven is not always present. THIS COULD RESULT IN VERY HOT LIQUIDS SUDDENLY BOILING OVER WHEN A SPOON OR OTHER UTENSIL IS INSERTED INTO THE LIQUID. To reduce the risk of injury to persons:

- i. Do not overheat the liquid.
- ii. Stir the liquid both before and halfway through heating it.
- iii. Do not use straight-sided containers with narrow necks.
- iv. After heating, allow the container to stand in the microwave oven for a short time before removing the container.
- v. Use extreme care when inserting a spoon or other utensil into the container.

CAUTION

To avoid personal injury or property damage, observe the following:

1. Do not deep fat fry in oven. Fat could overheat and be hazardous to handle.
2. Do not cook or reheat eggs in shell or with an unbroken yolk using microwave energy. Pressure may build up and erupt. Pierce yolk with fork or knife before cooking.
3. Pierce skin of potatoes, tomatoes, and similar foods before cooking with microwave energy. When skin is pierced, steam escapes evenly.
4. Do not operate equipment without load or food in oven cavity.
5. Microwave popcorn should not be popped in oven.
6. Do not use regular cooking thermometers in oven. Most cooking thermometers contain mercury and may cause an electrical arc, malfunction, or damage to oven.
7. Do not use metal utensils in oven.
8. Do not use aluminum foil in oven
9. Never use paper, plastic, or other combustible materials that are not intended for cooking.
10. When cooking with paper, plastic, or other combustible materials, follow manufacturer's recommendations on product use.
11. Do not use paper towels which contain nylon or other synthetic fibers. Heated synthetics could melt and cause paper to ignite.
12. Do not heat sealed containers or plastic bags in oven. Food or liquid could expand quickly and cause container or bag to break. Pierce or open container or bag before heating.
13. To avoid pacemaker malfunction, consult physician or pacemaker manufacturer about effects of microwave energy on pacemaker.
14. An authorized servicer MUST inspect equipment annually. Record all inspections and repairs for future use.

SAVE THESE INSTRUCTIONS

Grounding and Installation

Grounding/Earthing Instructions



Oven MUST be grounded. Grounding reduces risk of electric shock by providing an escape wire for the electric current if an electrical short occurs. This oven is equipped with a cord having a grounding wire with a grounding plug. The plug must be plugged into an outlet that is properly installed and grounded.

Consult a qualified electrician or servicer if grounding instructions are not completely understood, or if doubt exists as to whether the oven is properly grounded.

Do not use an extension cord.

If the product power cord is too short, have a qualified electrician install a three-slot receptacle. This oven should be plugged into a separate circuit with the electrical rating as provided in product specifications. When the combination oven is on a circuit with other equipment, an increase in cooking times may be required and fuses can be blown.

External Equipotential Earthing Terminal *(export only)*

Equipment has secondary earthing terminal. Terminal provides external earthing connection used in addition to earthing prong on plug. Located on outside of oven back, terminal is marked with symbol shown at right



Installation

STEP 1 - Unpack Oven

- Inspect oven for damage such as dents in door or inside oven cavity.
- Report any dents or breakage to source of purchase immediately.
Do not attempt to use oven if damaged.
- Remove all packing materials from oven interior.
- If oven has been stored in extremely cold area, wait a few hours before connecting power.
- If you plan to program via Ethernet, remove plastic plug from port on the right rear of oven. Gently use pliers if necessary.

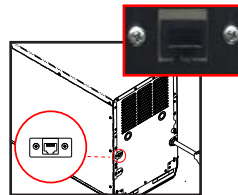

STEP 2 - Place Oven on Counter

- Recommended countertop surface depth is 28" (71 cm).
- Do not install oven next to or above source of heat, such as pizza oven or deep fat fryer. This could cause oven to operate improperly and could shorten life of electrical parts.
- Do not block or obstruct oven filters. Allow access for cleaning.
- Install oven on level countertop surface.
- Outlet should be located so that plug is accessible when oven is in place.

STEP 3 - Install Cook Plate

- Install oven cook plate
 1. Oven cavity must be cool to touch.
 2. Place cook plate in oven with curved edge toward the front of cavity.

⚠ DO NOT cook food directly on floor of oven.

⚠ WARNING

To avoid risk of electrical shock or death, this oven must be grounded and plug must not be altered.

⚠ WARNING

Excessive Weight Hazard
Use two or more people to move and install oven.
Failure to do so can result in back or other injury

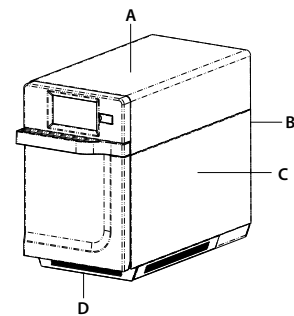

Oven Clearances

- A. Allow at least 2" (5.1 cm) of clearance around top of oven. Proper air flow around oven cools electrical components. With restricted air flow, oven may not operate properly and life of electrical parts is reduced.
- B. There is not an installation clearance requirement for the back of the oven.
- C. Allow at least 1/2" (1.27 cm) of clearance around sides of oven.
- D. Install oven so oven bottom is at least 3 feet (91.5 cm) above floor.

Cooking Tips

1. Metal containers can be used in the ARX & MRX oven with a height no more than 1½ inches (38mm). Different types of metal conduct heat at different speeds. Aluminum heats faster than stainless steel. Avoid using silicone pans and accessories.
2. Stage cooking aids in retaining the quality of frozen and delicate foods. Finishing baked goods at 0% Microwave and Fan is a great way to get the added browning and crisping without overcooking.
3. Take advantage of the accessories:
 - **Cook Plate Shelf Accessory** (CP10): Aids in browning and crisping of breads, pizzas, and more.
 - **Non-Stick Basket** (SB10S, TB10S, MB10S): Aids in browning and crisping of food. Also makes cleaning up easier. Great for breaded products like chicken fingers, fries, mozzarella sticks, jalapeno poppers. (SB10S, TB10S, MB10S have solid bottom)
 - **Pizza Stone**(ST10R): Aids in crisping and browning breads and pizzas.
 - **Panini Grill Accessory** (RGR10): Aids in adding grill marks on a product.
 - **Oven Paddle** (PA10, PA10R): Aids in removal of sandwiches and pizza from ARX and MRX high speed combination ovens. PA10R paddle designed to store under ARX and MRX ovens with installed LG10 leg kit (purchased separately).
 - **Non-Stick Liner Kit** (TL10R): Make cleanup easier and protect oven components.
 - **Leg Kit** (LG10): Lifts oven 4 inches (102 mm).
 - **Oven Back Cover** (BC10R): Color-matched back cover hides spacers, power cord, vents and labels. Allows for open platform, front of the house installation.
 - **Stacking Cart** (SC10R): Cart used for stacking neatly installing 2 ovens, one on each shelf, with accessory shelf below
 - **Top Shelf Accessory** (TS10R): Accessory rack with sides for top-of-oven installation. Allows operator to conveniently store and access paddle, baskets, etc.
 - Ceramic Dish: Great for foods that need to be contained such as ready-to-serve foods, cut vegetables or soups. (Available off the shelf)
4. The most frequently used oven temperature is 520° F (270° C). Reduce the oven temperature if the product is cooked for an extended period of time.
5. Line pans with parchment paper for easy removal of food after heating and cleaning.
6. Muffin tins (6 cup) work great for individual cakes & brownies. Spray with cooking spray prior to cooking for easy removal of food after heating.
7. Frequent cleaning prevents unnecessary buildup that may affect the oven performance.
8. Use a cleaner such as ACP Oven Cleaner (CL10 (US), CL10W (EU)) & ACP Oven Shield Protectant (SH10 (US), PR10W (EU)), or another cleaning product that does NOT contain ammonia, phosphates, chlorine, sodium hydroxide or potassium hydroxide as they can damage critical oven parts and may void the warranty on those parts. For best results, use non-stick liners and replace whenever you encounter excessive peeling or wear.
9. Items will be hot when finished cooking. Use oven mitt, tongs ,or pizza paddle to safely remove items from oven.

When to Use Stage Cooking

Stage cooking enables you to use up to four different cooking cycles or stages to be used consecutively without repeated input from the user. Stage cooking can be set to defrost food initially, then cook it, and then keep the food warm until serving time.

Note: Maximum cook time cannot exceed 99:99 (100 minutes and 39 seconds).

Example:

EGG ROLLS (FROZEN)

Total Cook Time: 1:30

Temperature: 520° F (270°C)

	Stage 1	Stage 2
Time	1:00	:30
Microwave	100%	90%
Fan	80%	60%

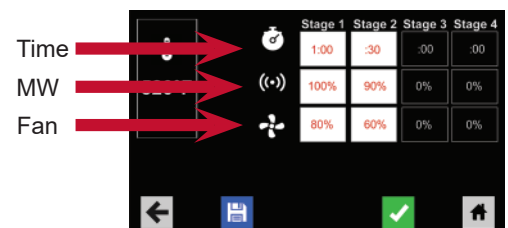

Features



1. Door Handle

Ergonomically designed for one handed operation.

2. Unit Serial Number

Located inside the door and on the back of the oven.

3. Air Filters

The oven has 3 magnetic air filters. Two located on the lower sides of the oven and one located below the door.

4. Touch Screen Display

Display provides user interface. Use for time input, programming and oven operation

5. ON/OFF Button

Use to turn oven on.

6. USB Port / Protective Cover

The oven is equipped with an USB Data Port. Use with standard flash drives.

7. Ethernet Port

The oven is equipped with an Ethernet Port. Use with standard Ethernet cables.

8. Cook Plate (CP10)

The oven is equipped with a removable cook plate which aids in browning and crisping of breads, pizzas, and more.









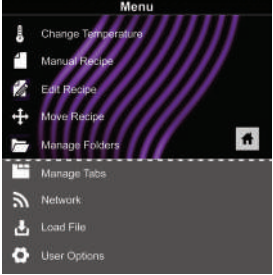

9. Emergency Power Reset Button

The oven is equipped with an emergency power reset button which allows users to quickly and easily restart the oven—without accessing the power source.

















To access reset button:

- a. Remove front magnetic air filter.
- b. Reach through far left-hand air intake hole and press upwards on button to reset oven

Touch Panel Menu Descriptions

	<p>MENU SCREEN</p> <ul style="list-style-type: none"> • Scroll up or down to choose from different categories
	<p>CHANGE TEMPERATURE</p> <ul style="list-style-type: none"> • Changes current oven temperature
	<p>MANUAL RECIPE</p> <ul style="list-style-type: none"> • Manually enter settings for a recipe
	<p>EDIT RECIPE</p> <ul style="list-style-type: none"> • Change current oven temperature
	<p>MOVE RECIPE</p> <ul style="list-style-type: none"> • Move/reorganize individual programmed recipes
	<p>MANAGE FOLDERS</p> <ul style="list-style-type: none"> • Add or edit recipe folders
	<p>MANAGE TABS</p> <ul style="list-style-type: none"> • Add or edit recipe tabs
	<p>NETWORK</p> <ul style="list-style-type: none"> • Connect the oven to Wi-Fi
	<p>LOAD FILE</p> <ul style="list-style-type: none"> • Transfer a menu file to the oven via USB flash drive
	<p>USER OPTIONS</p> <ul style="list-style-type: none"> • Modify a variety of user options such as key beep, temperature, etc.

Touch Screen Icon Descriptions

	<p>POWER ON ICON</p> <ul style="list-style-type: none"> Press to preheat oven. (<i>Fan will continue to run if temperature is over 200°F / 95°C</i>).
	<p>MENU ICON</p> <ul style="list-style-type: none"> Press to access a menu screen for manually editing recipes, changing user options, etc.
	<p>HOME ICON</p> <ul style="list-style-type: none"> Press to return to the home screen
	<p>TIME ENTRY</p> <ul style="list-style-type: none"> Indicates the time entry column in manual cooking entry
	<p>MICROWAVE POWER ENTRY</p> <ul style="list-style-type: none"> Indicates the microwave power entry column in manual cooking entry
	<p>FAN POWER ENTRY</p> <ul style="list-style-type: none"> Indicates the fan power entry column in manual cooking entry
	<p>SAVE ICON</p> <ul style="list-style-type: none"> Press to save a manually programmed recipe and return to the main screen
	<p>GREEN CHECK MARK ICON</p> <ul style="list-style-type: none"> Press to begin cooking after manually entering a recipe. Press to save changes
	<p>BACK ICON</p> <ul style="list-style-type: none"> Press to return to previous screen
	<p>NEXT ICON</p> <ul style="list-style-type: none"> Press to move to next screen
	<p>DELETE ICON</p> <ul style="list-style-type: none"> Press to delete menu item, folder, or network
	<p>PAUSE ICON</p> <ul style="list-style-type: none"> Press to pause a cook cycle
	<p>STOP ICON</p> <ul style="list-style-type: none"> Press to cancel a cook cycle. Press to stop and return to the main screen.
	<p>NEW FOLDER ICON</p> <ul style="list-style-type: none"> Press to add new folder.
	<p>FOLDER ICONS</p> <ul style="list-style-type: none"> Used to organize programmed recipes. Can be customized with color, icon, or image <i>Example: Pizza folder - cheese pizza, pepperoni pizza, etc.</i>
	<p>TAB ICONS</p> <ul style="list-style-type: none"> Used to organize programmed recipes. <i>Example: AM or PM menus</i>
	<p>PROGRAMMED RECIPE ICON</p> <ul style="list-style-type: none"> Press to begin the cook cycle for the desired recipe

General Oven Operation

Power On Oven, Preheat

This oven can be set to a preheat temperature between 200°F (95°C) and 520°F (270°C).

Oven must be plugged in. (Screen will power on to "Standby mode" within approximately 30 seconds.)



Touch green "Power" icon

Preheat temperature of oven will appear in display.



Touch the power key again to interrupt preheating, or touch the blue menu icon to access main menu and user options.

Power Off Oven



At the end of the day, turn the oven off by touching the green "Power" icon on the screen. The oven will begin cooling down..

The oven fan will continue to run to cool the oven.

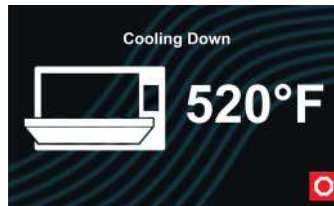

"Cooling Down" screen appears and stays on until oven temperature is below 200°F (95°C)

⚠ Caution: To avoid damage to the convection motor do not turn off power by unplugging the unit or shutting off the power breaker until the fan stops.

Methods of Cooking and Programming

- Cooking with Preprogrammed Menu Items
- Manual Cooking and Oven Programming
- Recipe and Menu creation via ACP Programming Application
- USB Programming
- Wi-Fi Programming
- Ethernet Programming

You may add and organize recipe information by creating new recipes, folders and tabs. See the following pages for more information. (p14-17)

To download and view example menus, please visit acpsolutions.com/oven-programming/

First Time Use Set User Options

There are several options you can change to customize the operation of the oven for your business. To access and edit user options, please see **page 22 and page 23**.

Set Time and Date settings for your local time. This oven maintains a data log which is used to diagnose and troubleshoot errors. An accurate date and time are important for the data log.

Preprogrammed Menu

The home screen on the oven displays recipe options. Scroll up and down with your finger to navigate through on screen menus and recipes. After the oven has preheated, the menu appears. The high speed oven comes preprogrammed with several menu items to simplify cooking.

Note: Please see the next page for settings of each preprogrammed menu item.

Standard Preprogrammed Menu Items:

- | | |
|------------------------|------------------------|
| 1. Breakfast Casserole | 10. Salmon |
| 2. Breakfast Sandwich | 11. Roasted Vegetables |
| 3. Omelet | 12. Baked Potato |
| 4. Tuna Melt | 13. Ice Cream Sandwich |
| 5. Crab Cakes | 14. Grilled Pineapple |
| 6. Pizza | 15. Chicken Wings |
| 7. Reuben Panini | 16. Fries |
| 8. Muffuletta Panini | 17. Shrimp |
| 9. Fish Tacos | |

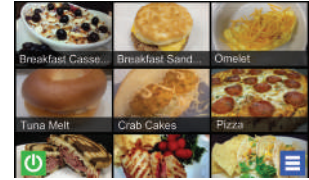

Cooking with Preprogrammed Menu Items

1. After oven has preheated to desired temperature, open oven door, place food in oven and close door
2. Scroll to choose desired food item from menu and touch the food item you wish to cook. The cook cycle will begin and screen will show remaining cook time.

Note: If “Preheat Warning” is enabled (customized user setting, see page 23), and preheat temperature differs from default preheat temperature, the control will interrupt cook cycle.





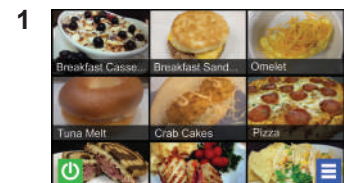





To guarantee that oven reaches desired temperature before cook cycle begins, enable “Preheat Warning” in user options.

3. At the end of the cooking cycle, the oven beeps, and displays animation. Use oven mitts and/or paddle to carefully remove food from oven.



Preprogrammed Menu Items

The high speed oven comes preprogrammed with several menu items to simplify cooking. You may use these items as a basis for developing new menu items.

RECIPE & OVEN TEMP		SETTINGS FOR 2000W UNIT				SETTINGS FOR 1000W UNIT			
	BREAKFAST CASSEROLE Temperature: 520°F (270°C)	STAGE	TIME	MW	FAN	STAGE	TIME	MW	FAN
		1	1:00	50%	0%	1	2:45	50%	10%
		2	0:40	40%	40%				
	BREAKFAST SANDWICH Temperature: 520°F (270°C)	STAGE	TIME	MW	FAN	STAGE	TIME	MW	FAN
		1	0:50	60%	10%	1	0:55	60%	0%
	OMELET Temperature: 520°F (270°C)	STAGE	TIME	MW	FAN	STAGE	TIME	MW	FAN
		1	1:00	60%	0%	1	2:10	60%	0%
		2	0:50	50%	10%				
	TUNA MELT Temperature: 520°F (270°C)	STAGE	TIME	MW	FAN	STAGE	TIME	MW	FAN
		1	0:20	60%	0%	1	0:45	60%	10%
		2	0:10	40%	10%				
	CRAB CAKES Temperature: 520°F (270°C)	STAGE	TIME	MW	FAN	STAGE	TIME	MW	FAN
		1	0:40	90%	10%	1	1:30	90%	10%
		2	0:25	60%	40%	2	0:15	60%	50%
		3	0:10	100%	100%				
	PIZZA Temperature: 520°F (270°C)	STAGE	TIME	MW	FAN	STAGE	TIME	MW	FAN
		1	2:00	40%	0%	1	2:00	80%	0%
		2	0:20	60%	30%	2	1:00	40%	0%
		3	0:10	70%	30%	3	0:10	100%	30%
		4	0:20	0%	60%				
	REUBEN PANINI Temperature: 520°F (270°C)	STAGE	TIME	MW	FAN	STAGE	TIME	MW	FAN
		1	0:40	60%	10%	1	1:00	60%	10%
	MUFFULETTA PANINI Temperature: 520°F (270°C)	STAGE	TIME	MW	FAN	STAGE	TIME	MW	FAN
		1	0:40	50%	50%	1	1:00	60%	50%
		2	0:05	80%	80%				
	FISH TACOS Temperature: 520°F (270°C)	STAGE	TIME	MW	FAN	STAGE	TIME	MW	FAN
		1	1:30	50%	30%	1	2:10	50%	30%
	SALMON Temperature: 520°F (270°C)	STAGE	TIME	MW	FAN	STAGE	TIME	MW	FAN
		1	1:55	40%	20%	1	2:30	50%	20%
		2	0:10	100%	20%	2	0:10	100%	20%
	ROASTED VEGETABLES Temperature: 520°F (270°C)	STAGE	TIME	MW	FAN	STAGE	TIME	MW	FAN
		1	1:30	100%	100%	1	2:00	100%	100%
	BAKED POTATO Temperature: 520°F (270°C)	STAGE	TIME	MW	FAN	STAGE	TIME	MW	FAN
		1	0:55	100%	10%	1	5:00	100%	10%
		2	2:00	80%	0%	2	2:45	80%	10%
		3	2:00	60%	10%				
	ICE CREAM SANDWICH Temperature: 520°F (270°C)	STAGE	TIME	MW	FAN	STAGE	TIME	MW	FAN
		1	0:35	30%	20%	1	0:35	50%	40%
	GRILLED PINEAPPLE Temperature: 520°F (270°C)	STAGE	TIME	MW	FAN	STAGE	TIME	MW	FAN
		1	1:00	80%	40%	1	1:00	80%	40%
	CHICKEN WINGS Temperature: 520°F (270°C)	STAGE	TIME	MW	FAN	STAGE	TIME	MW	FAN
		1	1:15	100%	0%	1	2:00	100%	0%
		2	1:15	80%	10%	2	2:00	100%	10%
	FRIES Temperature: 520°F (270°C)	STAGE	TIME	MW	FAN	STAGE	TIME	MW	FAN
		1	1:00	100%	100%	1	1:30	100%	80%
	SHRIMP Temperature: 520°F (270°C)	STAGE	TIME	MW	FAN	STAGE	TIME	MW	FAN
		1	1:05	30%	60%	1	1:05	60%	60%

ABBREVIATION MEANINGS:
 MW = Microwave Energy
 FAN = Convection Energy

Manual Cooking

Note: “Manual cooking” must be enabled in user options (see page 22 and page 23)

Use manual cooking when a specific entered time and cooking power levels are desired. It’s very useful when you are experimenting with new food items. Maximum cook time is 99:99 (100 minutes and 13 seconds) . Microwave and Fan can be set to power levels between 0-100%.

Note: You may also create and edit recipes using the ACP Programming Application.



1. After oven has preheated touch blue menu icon.

Note: To guarantee that oven reaches the desired temperature before the start of cook cycle, enable “Preheat Warning” in user options

2

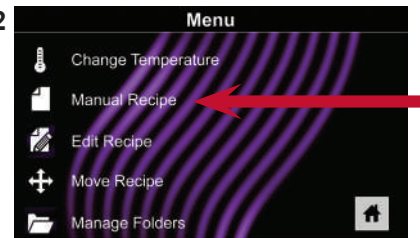

2. Touch the “Manual Recipe” option.



3. To change **cooking temperature** for recipe, touch temperature icon on the left, and input new temperature. Two frequently used temperatures will appear for quick selection.

Touch green check mark after inputting a temperature.



4. For Stage 1, enter **cooking time** by touching time entry box. A number pad will appear. Enter the desired cook time. Touch the “OK” icon.



5. Select desired **microwave power** by touching microwave power entry box. Choose from options ranging from 0% - 100%.



6. Select desired **fan speed** by touching fan speed entry box. Choose from options ranging from 0% - 100%.

7. Repeat steps 4-6 for each cooking stage, if more than one cooking stage is necessary.

Note: To save without cooking first, touch the save icon.  Follow instructions on the next page.



8. Open oven door and place food in oven. Touch green check mark icon to begin cooking.

Once the cook cycle is complete, open door and use oven mitts and/or paddle to carefully remove food.

The display will return to the manual input screen. See instructions on next page to save and edit menu item from manual cook.

4-6

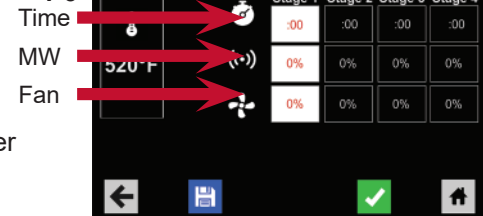

Manual Programming

Save a Menu Item from Manual Cook:



1. To save the settings and create menu item, touch the blue save icon



2. Choose a background color and icon, or an image to customize the menu item. Touch the right arrow to move to the next screen.



3. Name recipe and touch the green check mark to save.

4. To reorganize menu items, you may touch, hold and drag them. Touch green check mark to complete this step and save the menu item.

Note: For larger, and more complex menus, it may be more manageable to create and edit menus using the ACP Programming Application. For detailed instructions, please visit: acpsolutions.com/oven-programming/



Manually Edit an Existing Menu Item:



1. Touch the blue menu icon at the bottom of the screen.

2. Touch the "Edit Recipe" option.

3. Touch the desired recipe to be edited. The control will prompt you to the manual editing screen, where you may revise the cooking settings.



To delete the menu item, touch the orange garbage can icon. Touch the green check mark to confirm, or touch the "X" to dismiss.

4. **Note:** Skip this step if you do not want to cook anything.

Open the oven door and place the food in the oven. Touch green check mark icon to begin cooking with the revised menu item settings. The display will return to the manual input screen at the end of the cook cycle.



5. Touch the right arrow icon to save any changes made to cook settings and move to the next screen.



6. If desired, choose a different background color. Touch the right arrow to select an image at the next screen. Touch the right arrow again to move to the next screen.



7. If desired, change the name of the recipe. Touch green check mark to save the menu item.

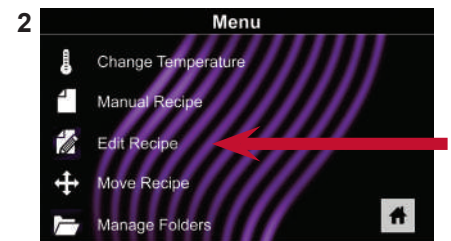

Manually Move Recipe:



1. Touch the blue menu icon at the bottom of the screen.

2. Touch the "Move Recipe" option.

3. Touch, hold, and drag recipes to different locations on the screen

Move a recipe into a folder: Touch, hold and drag the recipe to the folder.

Move a recipe out of a folder: Touch, hold and drag the recipe to the top of the screen

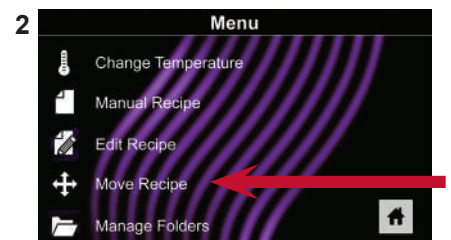

Manual Organization: Folders

Manually Create a Recipe Folder:

Note: You may also create folders using the ACP Programming Application.



1. Touch the blue menu icon at the bottom of the screen.
2. Touch the "Manage Folders" option in the menu screen.



3. To create new folder, touch grey folder icon at the bottom of screen.



4. Choose a background color and icon, or an image to customize the folder. Touch the right arrow icon.



5. Name folder and touch the green check mark to save.



6. Confirm that your new folder appears on the main screen. Touch the green check mark icon again to save the new folder.

2

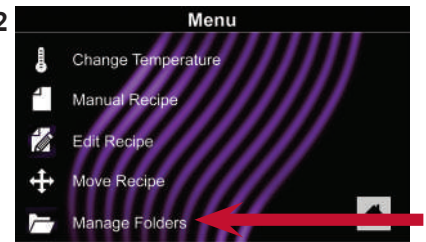

Manually Edit an Existing Recipe Folder:

Note: You may also edit folders using the ACP Programming Application.



1. Touch the blue menu icon at the bottom of the screen.
2. Touch the "Manage Folders" option in the menu screen
3. Touch the desired folder to be edited.



To delete the folder: Touch the orange garbage can icon. Touch the check mark to confirm deletion. Or, touch the "X" to dismiss.



4. If desired, select a different photo, icon, or color for the folder. Touch the right arrow icon to move to the next screen.



5. If desired, change the name of the recipe. Touch green check mark to save changes.



6. Touch the green check mark icon once more to save the revised folder.



Manual Organization: Tabs

Manually Create a Recipe Tab

Note: You may also add recipe tabs using the ACP Programming Application.



1. Touch the blue menu icon at the bottom of the screen.
2. Touch the "Manage Tabs" option in the menu screen.



3. Touch the "Add Tab" option
4. A new tab will appear at the top of the screen.



5. Touch the home icon to return to the main screen.

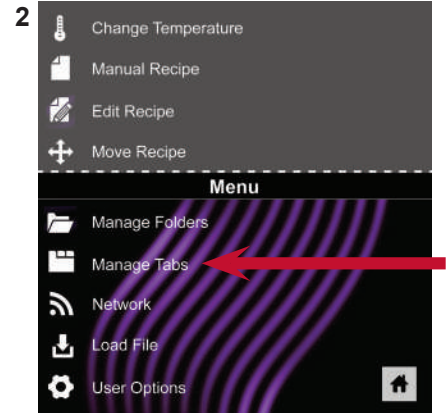

Manually Edit an Existing Recipe Tab

Note: You may also edit tabs using the ACP Programming Application.



1. Touch the blue menu icon at the bottom of the screen.
2. Touch the "Manage Tabs" option in the menu screen.
3. Touch the desired tab to be edited.



Change the image on the tab: Touch the "Choose Icon" option. Select an image. Touch the green check mark icon.



Add text to the tab: Touch the "Enter Text on Tab" option. Enter the desired text. Touch the green check mark to save.

Relocate the tab: Touch the "Move Tab Right" or "Move Tab Left" option.

Delete the tab: Touch the "Delete Tab" option.



4. After changes have been made, touch the home icon to save and return to the main screen.

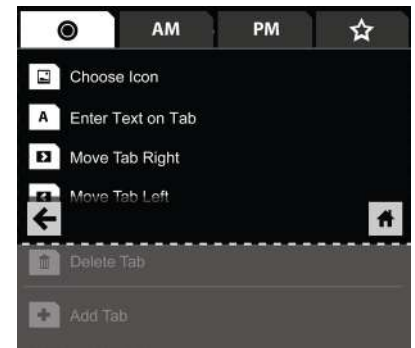

Oven Programming: USB Flash Drive

Caution: Uploading a new file will overwrite existing items on oven. To ensure items are not lost, first backup files by exporting to USB drive.

Export Menu via USB Flash Drive



1. Touch the blue menu icon at the bottom of the screen.
2. Scroll down and touch the “Load File” option
3. When prompted, insert the flash drive into the USB port
4. When prompted, select “Export Files”.
“Copying Files” screen will appear.
Do **not** remove USB Flash Drive until “Success” screen appears.
5. Once the file have copied, touch the “Home” icon to return to the main screen. Remove USB Flash Drive.
Settings and menu items will be loaded on USB Flash Drive and ready to share or open in ACP Programming Application .



Open Menu in ACP Programming Application

Note: For more comprehensive instructions, see *ACP Programming Application User Guide online*

1. Insert flash drive into USB port on computer.
2. Open ACP Programming Application.
3. Select “File,” then “Open.” Navigate to flash drive.
Select the menu file and open.

Import Menu via USB Flash Drive



1. Touch the blue menu icon at the bottom of the screen.
2. Scroll down and touch the “Load File” option
Caution: Uploading a new file will overwrite existing items on oven. To ensure items are not lost, first backup files by exporting to USB drive.
3. When prompted, insert the flash drive into the USB port
4. Touch the desired file to be uploaded.
5. Once file has uploaded, touch the “Home” icon to return to the main screen.
Settings and menu items will now be loaded and ready to use.

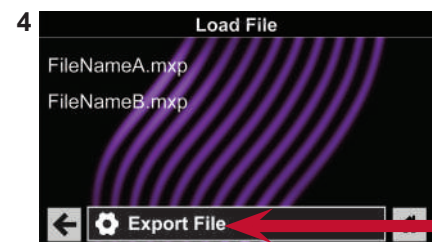
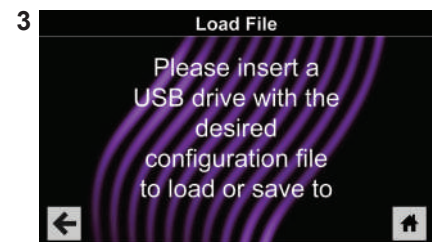
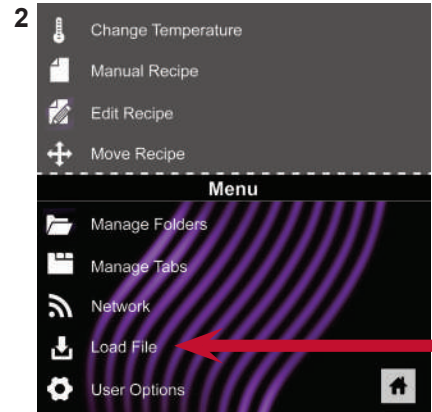

Oven Programming: Wi-Fi and Ethernet

Connect Oven to Network:



1. Touch the blue menu icon at the bottom of the screen.
2. Touch the "Network" option.
3. Connect to network using your choice of Ethernet or Wifi:

To connect via Wi-Fi:

- Enable Wi-Fi capability by touching the "On" option.
- Select the desired Wi-Fi network. Enter the network's password. If the network does not immediately appear, touch "Search" to locate the Wi-Fi network.

To connect via Ethernet:

- Make sure the Ethernet cord is plugged into the back of the oven and wall jack. If necessary, use pliers to gently remove plastic plug from Ethernet port on right rear of oven. Insert Ethernet cable.

2

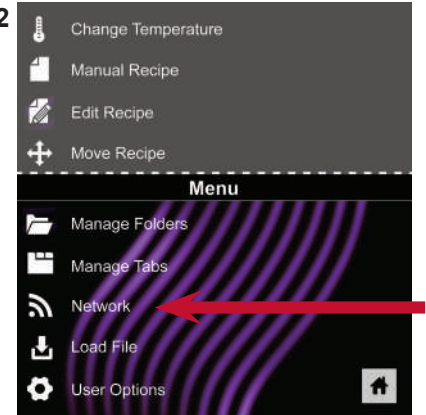

Connect Computer to Oven via Wi-Fi/Ethernet:

1. Connect computer to same network and enter password.
2. An IP address will appear on oven control once it has connected to the network. Open an internet browser window on computer and type in the IP address exactly as it appears on oven screen.
3. Enter your log-in information:

Log-in Information	
Username	ACP_MXP
Password	Express

4. The oven and computer are now connected.

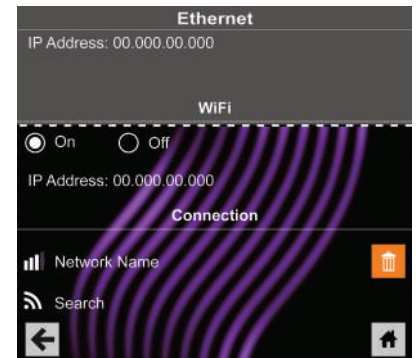

Transfer Recipe Information via Wi-Fi/Ethernet:

1. After connecting the computer to the oven and logging in, click on the "Upload Recipes" tab in browser window.

Caution: Uploading a new file will overwrite existing items on oven. To ensure items are not lost, first backup files by exporting to USB drive.



2. Upload menu file by following the instructions on web page. Touch the green check mark.

3. Once the file has been fully uploaded, a message will appear that says "Upload Successful!" The recipes will be imported when the oven enters standby mode."



4. To cycle the oven through standby mode, touch the home icon then the green power icon. Oven will begin cooling down. Touch the red stop icon to return to home screen. Menu items and settings will be uploaded and ready to use.

Need to update recipe information for multiple locations?

Contact us at commercialservice@acpsolutions.com for more details about SFTP and Enterprise Wi-Fi support.



Care and Cleaning

Follow the recommendations below and on the following page for proper maintenance of ARX & MRX ovens.

⚠ The use of caustic cleaning products or those containing ammonia, phosphates, chlorine, sodium or potassium hydroxide (lye) can damage critical oven parts. Do not use water pressure type cleaning systems.

Use of unapproved cleaning agents will void the terms of the warranty.

Recommended Cleaning Supplies:

Damp towel, plastic scouring pad, ACP Oven Cleaner (Item CL10 (US), Item CL10W (EU)), ACP Oven Shield Oven Protectant (Item SH10 (US), Item PR10W (EU)), mild liquid dishwashing detergent, rubber gloves, safety glasses, microfiber cloth

For a new oven, before using it for the first time:

When oven is clean, spray damp towel with ACP Oven Shield Protectant (SH10) and wipe all interior surfaces. Do not remove Oven Shield. Turn oven on and pre-heat to start cooking.

⚠ WARNING

Wear protective gloves and protective glasses when cleaning the oven.

To prevent burns, handle utensils, accessories, and door with care. Allow oven, utensils, and accessories to cool before cleaning. Oven, utensils, and accessories become hot during operation

Failure to maintain the oven in a clean condition could lead to deterioration of the surface that could adversely affect the life of the appliance and possibly result in a hazardous situation.

Best Practices

- DO** clean oven daily.
- DO** use non-caustic cleaner.
- DO** wear protective gloves and glasses while cleaning.
- DO** always use recommended cleaning supplies: *Damp towel, plastic scouring pad, ACP Oven Cleaner (CL10) and ACP Oven Shield Protectant (SH10).*
- DO** allow oven and tools to cool before cleaning
- DO** remove food from oven at end of cycle.
- DO** use only accessories that are both high temperature oven-safe and microwave-safe.
- DO** wash cook plate with warm, soapy water and air dry
- DO** place cookware in center of oven rack, not touching oven sides.

- Do NOT** use caustic cleaning products or those containing ammonia, phosphates, chlorine, sodium or potassium hydroxide (lye).
- Do NOT** use water pressure style cleaning systems
- Do NOT** spray cleaning solution into perforations.
- Do NOT** use abrasive scouring pads to clean cavity ceiling cover or red sealant in cavity corners.
- Do NOT** cook foods with plastic wrap on them.
- Do NOT** operate oven without a load (empty) in microwave mode.

Any chemical questions please refer to Chemco's MSDS' for ACP Oven Cleaner and ACP Oven Shield Protectant or contact ACP, Inc. ComServ Customer Service.

Amana® Commercial ARX
Contact:



866-426-2621

MenuMaster® MRX
Contact:



866-811-8559

email: commercialservice@acpsolutions.com

Care and Cleaning

DAILY CLEANING:	
1. PREPARE OVEN	<p>1. Shut oven off by pressing ON/OFF button. The fan will run for a few minutes to cool the oven interior faster. Let the oven interior reach room temperature before cleaning.</p> <p>Note: <i>To accelerate cool down time of oven, put a tray filled with ice in oven cavity after shutting the oven down.</i></p> <p>2. Once cooled, remove cook plate and other accessories from the cavity.</p>
2. CLEAN OVEN INTERIOR	FOR OVENS WITH NON-STICK LINERS
	<p>1. Using a warm, damp, clean towel, wipe the oven interior. Rinse the towel and wring dry. Repeat 2-3 times to remove remaining particles from the oven.</p> <p>2. FOR STUBBORN DEBRIS, use ACP Oven Cleaner (CL10):</p> <p>a. Wear rubber gloves and safety glasses. Spray oven door and cavity with ACP Oven Cleaner (CL10). Avoid spraying into perforations. Allow cleaner to soak for 2 minutes.</p> <p>⚠ Do NOT spray cleaning solution into perforations.</p> <p>b. WIPE OVEN INTERIOR. Using a damp clean towel, wipe the oven interior, then rinse the towel and wring dry. Repeat 2-3 times to remove remaining oven cleaner and particles from the oven.</p>
2. CLEAN OVEN INTERIOR	FOR OVENS WITHOUT NON-STICK LINERS
	<p>1. Wear rubber gloves and safety glasses.</p> <p>2. CLEAN OVEN INTERIOR: Spray oven door and cavity with ACP Oven Cleaner (CL10).</p> <p>⚠ Do NOT spray cleaning solution into perforations Allow cleaner to soak for 2 minutes.</p> <p>a. Clean metal portions of the oven door and interior using a plastic scouring pad.</p> <p>b. Clean cavity ceiling cover with a damp cloth sprayed with cleaner and apply gentle pressure to clean cavity ceiling cover.</p> <p>c. Clean perforated area with damp cloth sprayed with cleaner.</p> <p>3. WIPE OVEN INTERIOR. Using a damp clean towel, wipe the oven interior, then rinse the towel and wring dry. Repeat 2-3 times to remove remaining oven cleaner and particles from the oven.</p> <p>4. APPLY OVEN SHIELD. When oven is clean, spray a thin layer of ACP Oven Shield (SH10) on all interior surfaces. Do not remove Oven Shield.</p>
3. CLEAN ACCESSORIES	<p>1. CLEAN COOK PLATE: Allow cook plate to cool before cleaning,</p> <p>a. Clean the cook plate with liquid dishwashing detergent such as Dawn®, and a non-abrasive sponge or soft bristle brush.</p> <p>b. FOR STUBBORN DEBRIS: soak cook plate in hot, soapy water for 10 minutes. Burnt-on foods should lift off after soaking. Maintain with Bar Keeper's Friend® cleanser and a plastic scouring pad, being sure to rinse thoroughly.</p> <p>⚠ Do NOT use lye-based cleaners (e.g., sodium hydroxide) as they react with aluminum and will degrade the surface</p> <p>2. For other accessories, please refer to instruction sheet included in original packaging</p>
4. CLEAN OVEN EXTERIOR	<p>1. CLEAN EXTERIOR DOOR and other surfaces with a clean cloth, sponge or nylon pad; using a mild detergent and warm water solution.</p> <p>2. CLEAN TOUCHSCREEN with a dry or damp microfiber cloth.</p> <p>⚠ Do NOT use Windex or other harsh chemicals. Do NOT spray liquid on the screen</p>
WEEKLY CLEANING	
1. CLEAN AIR FILTERS	<p>1. Remove all 3 of the magnetic air filters located along the front base and sides of the oven.</p> <p>⚠ CAUTION: Do NOT operate oven without air filters in place.</p> <p>2. Wash filters in a mild detergent solution made with warm water.</p> <p>3. Rinse and dry thoroughly.</p> <p>4. Place the clean filters on oven front base and sides.</p>

User Options

There are several options you can change to customize the operation of the oven for your business. The table on page 23 shows these options; the **factory setting is shown in bold type**.

Access and Modify User Options:



1. Touch the blue menu icon at the bottom of the screen.
2. Scroll down and touch to select "User Options."



3. Use this menu to modify oven settings.
Touch the left arrow to return to the menu after making each change.

Note: You may also make user options changes using the ACP Programming Application.

Note: Programming the preheat temperature in the user options menu will set the oven to heat to a certain temperature each time it is powered on

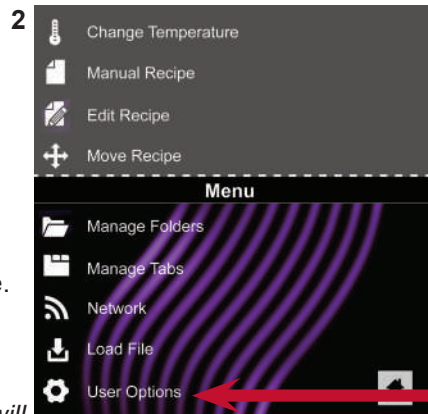

TIME AND DATE

This oven maintains a data log of information, including date and time of operation. This information is used to diagnose and troubleshoot errors. An accurate date and time are important for the data log.

1. Select **Time**. Choose format (12 HR or 24 HR). Enter local time.
2. Touch the left arrow to return.
3. Select **Date**. Choose format (MM/DD/YYYY or DD/MM/YYYY). Enter today's date.
4. Touch the left arrow to return.

ALLOW MANUAL COOK

Allow Manual Cook option must be enabled in order to view **Allow Manual Save** options.

PIN CODE

If enabling **PIN Code**, select a 4-digit numeric PIN. PIN Code must be enabled before trained technician may enter *Service Mode*

CLEAN FILTER REMINDER

When "Clean Filter" message displays, clean air filters thoroughly. **Cleaning the air filters will not shut off message.** Message will automatically stop displaying after 24 hours.

- a. Check "Filter Cleaned" box to confirm clean.
- b. Select "Dismiss" to close popup.

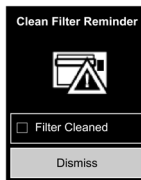

Note: If "Filter Cleaned" box is checked, reminder time resets.

Necessary cleaning frequency of air filters dependant on microwave use and environmental conditions. Once frequency is determined, set the user option for appropriate time frame.

Air filters and vents must be cleaned regularly to prevent overheating of oven. Refer to "1. Clean Air Filters" on page 21 for cleaning instructions.

PREHEAT WARNING

To guarantee that oven reaches the desired temperature before the start of cook cycle, enable **Preheat Warning** in user options. Enable setting when using recipe with different starting temperature than default **Preheat Temperature**

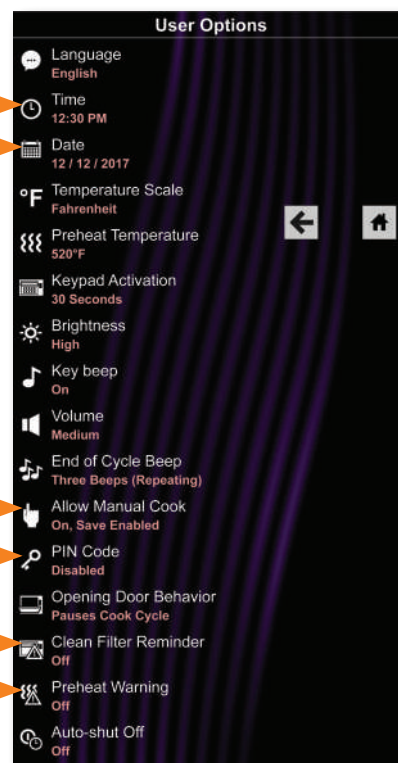

Default User Options



The table below shows the standard user options; the **factory setting for each model is shown in bold type.**

User Option	STANDARD DEFAULT PER MODEL	
	ARX & MRX, 60Hz	ARX & MRX, 50Hz
Language	English , Chinese (Mandarin), Japanese, Korean, Russian, German, French, Italian, Polish, Danish, Greek, Latin, Swedish, Portuguese, Spanish, Thai, Lao, Dutch, Vietnamese, Arabic, Ukrainian, Filipino, Norwegian, Hindi, Bengali	English , Chinese (Mandarin), Japanese, Korean, Russian, German, French, Italian, Polish, Danish, Greek, Latin, Swedish, Portuguese, Spanish, Thai, Lao, Dutch, Vietnamese, Arabic, Ukrainian, Filipino, Norwegian, Hindi, Bengali
Time <i>*time entry can be customized by hour and minute</i>	*12 Hr *24 Hr	*12 Hr *24 Hr
Date <i>*date entry can be customized by day, month, and year</i>	*MM / DD / YYYY *DD / MM / YYYY	*MM / DD / YYYY *DD / MM / YYYY
Temperature Scale	Celsius Fahrenheit	Celsius Fahrenheit
Preheat Temperature <i>200°F - 520°F (93°C - 270°C)</i>	520°F (270°C)	270°C (520°F)
Keypad Activation	30 seconds 60 seconds 2 minutes	30 seconds 60 seconds 2 minutes
Brightness	Low Med High	Low Med High
Key Beep	On Off	On Off
Volume	Low Medium High	Low Medium High
End of Cycle Beep	Three Beeps (Once) Three Beeps (Repeating) Continuous Until Door is Opened	Three Beeps (Once) Three Beeps (Repeating) Continuous Until Door is Opened
Allow Manual Cook	On Off	On Off
Allow Manual Save	On Off	On Off
PIN Code <i>*must be a 4-digit numeric PIN</i>	*On Off	*On Off
Opening Door Behavior	Reset Timer Pauses Cook Cycle	Reset Timer Pauses Cook Cycle
Clean Filter Reminder	Every 7 Days Every 30 Days Every 90 Days Off	Every 7 Days Every 30 Days Every 90 Days Off
Preheat Warning	On Off	On Off
Auto Shut Off	2 Hours 4 Hours 8 Hours Off	2 Hours 4 Hours 8 Hours Off

Before Calling for Service

WARNING

To avoid electrical shock which can cause severe personal injury or death, do not remove outer case at any time. Only an authorized servicer should remove outer case. This is a Class A product. In a domestic environment this product may cause radio interference in which case the user may be required to take adequate measures.

PROBLEM	POSSIBLE CAUSE
Oven does not operate	Confirm oven is plugged in. Confirm oven is connected to a grounded circuit. Check fuse or breaker.
Oven operates intermittently	Check air filters and discharge air vents
If oven does not accept entries when pad is pressed	Make sure oven is preheated. Open and close door, press pad again.
Oven fan turns on while oven is not preheating or cooking	Normal operation
When I turn the oven OFF, the display is still lit	Normal operation
Clean Filter displays	This is normal and will appear for 24 hours.
Frozen oven display	Oven display needs to reset. Models without reset button: <i>Unplug oven. Wait 5 seconds. Plug back in.</i> Models equipped with reset button: a. Remove front magnetic air filter. b. Reach through far left hand air intake hole and press upwards on button to reset oven  
"G0" error displays on screen	Oven Exceeded Max. Temp. <i>After oven cools, press the red reset button found on the back, bottom-right hand corner of unit.</i> <i>If "G0" error continues to appear, or reoccurs, contact ACP, Inc. ComServ Customer Service</i>

Amana® Commercial ARX
Contact:



866-426-2621

MenuMaster® MRX
Contact:



866-811-8559

email: commercialservice@acpsolutions.com

For full product documentation visit:
www.acpsolutions.com